



Executive furniture Chefzimmerprogramm



Executive set of office furniture
Chefzimmerprogramm

design: Piotr Kuchciński

Modern and minimalist range of managerial furniture called IN, has been designed by Piotr Kuchcinski. The unique style is based on unusual materials' combination like natural American walnut, American cherry and natural oak veneers combined with anodised aluminium that gives harmonious furniture line. Structural, functional solutions of original forms and shapes make the managerial set IN unique and distinguished.

Die Chefzimmerkollektion IN ist in einem neuartigen, minimalisierten Stil gehalten. Verwendet wurden ausschließlich Materialien von höchster Qualität: Furnier aus der amerikanischen Nuss und der amerikanischen Kirsche, der Wenge, Naturnuss sowie Aluminium.

COLLECTION ELEMENTS / ELEMENTE DER KOLLEKTION

DESKS AND TABLES / SCHREIBTISCHE UND TISCHE

DESKTOP / TISCHPLATTE	36 mm chipboard covered with natural veneer, varnished with mat laquer / Plattenstärke 36mm, Furnier, Klarlack halbmatt	
FRAME / GESTELL	Version 1 frame is made from anodised aluminium profile / Aluminiumprofil anodisiert	Version 2 60 mm chipboard covered with natural veneer, finished with aluminium profile / Plattenstärke 60 mm, Furnier, Füße: Aluminiumprofil
SHIELDS / KNEIBLENDEN	25mm chipboard covered with natural veneer, assembled to the desktop / Plattenstärke 25 mm, Furnier Standard, Zum Tischplatte montiert	
NOTE / WICHTIG!	in I12 and I13 coffee tables' tops 25mm thick / I12 und I13 Couchtische, Tischplattenstärke 25mm	

MODULAR CONFERENCE TABLE / MODULKONFERENZTISCH

DESKTOP / TISCHPLATTE	36 mm chipboard covered with natural veneer, varnished with mat laquer / Plattenstärke 36mm, Furnier, Klarlack halbmatt	
LIGHTNING / BELEUCHTUNG	glass satinato 4 mm thick; lighting: white, 230V; IMPORTANT: modules I-40 and I-41 are without lighting / Satiniertes Glas, Stärke 4mm; Beleuchtung: weißes. ACHTUNG! Tische I40 und I41 ohne Beleuchtung	
FRAME / GESTELL	frame is made from anodised aluminium profile / Aluminiumprofil anodisiert	
NOTE / WICHTIG !	modular tables I-33, I-34, I-35 and I-40 and I-41 are to be set together, do not exist as a separate tables / Tischelemente: I-33, I-34 und I-35 nur im Satz	

CABINETS AND PEDESTALS IN NATURAL VENEER / SCHRÄNKE UND CONTAINER IN FURNIER

BODY AND FRONT / KORPUS UND FRONT	36 mm chipboard covered with natural veneer, varnished with mat laquer / MDF-Platte Furnier, Klarlack halbmatt
BACK WALL / RÜCKWAND	chipboard covered with natural veneer, varnished with mat lacquer / MDF-Platte Furnier, Klarlack halbmatt
INSIDE FINISHINGS / INNEN ABSCHLÜSSE	chipboard covered with natural anegre veneers coloured and varnished with mat lacquer / MDF-Platte Furnier, Klarlack halbmatt
GLASS DOOR / GLASTÜR	satinato or graphite glass in aluminium frame, handles made from aluminium profile / Milchglas, Alurahmen, Griffe Aluminium
FRAME / GESTELL	anodised aluminium profile / Aluminium anodisiert Profil

CABINETS AND PEDESTALS IN GLOSSY LACQUER / SCHRÄNKE UND CONTAINER HOCHGLANZ LACKIERT

BODY AND FRONT / KORPUS UND FRONT	18 and 25 mm lacquered mdf board, glossy lacquer only on right sides and edges / 18 und 25mm MDF-Platte, lackiert; Außenseite und Ecken - Lack Hochglanz
BACK WALL / RÜCKWAND	right side of backwall semi mat lacquer / Außen - Halbmatt
INSIDE FINISHINGS / INNEN ABSCHLÜSSE	left sides and inside semi mat lacquer / Schrankinnere - Halbmatt
NOTE / WICHTIG !	little specks of diameter up to 1mm up to 5 pieces per 1 square metre of the furniture surface are acceptable / Max. 5 kleine Einschlüsse pro m2 der Möbeloberfläche, Durchmesser max. 1mm, sind zulässig

FINISHING / AUSFÜHRUNG

DESKS AND TABLES / SCHREIBTISCHE/TISCHE

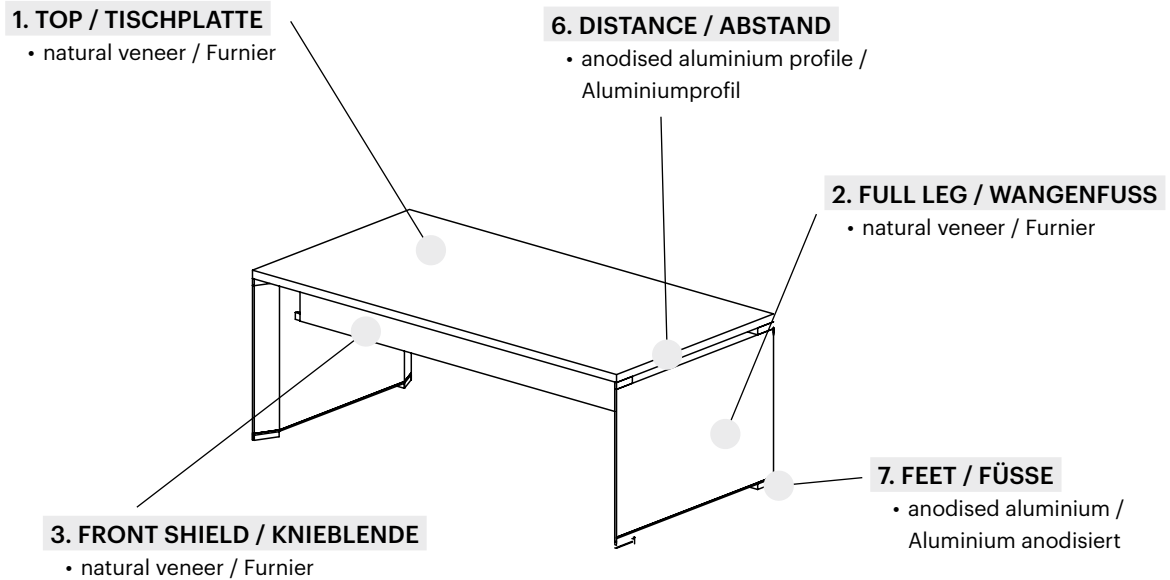

CABINETS AND PEDESTALS / CONTAINER UND SCHRÄNKE

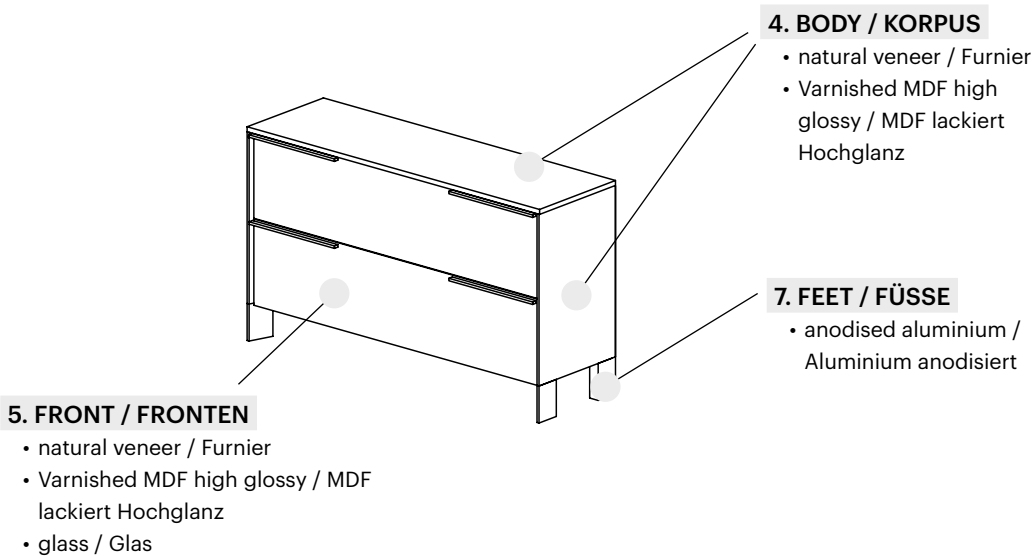

AVAILABLE COLOURING / FARBEN

DESKS AND TABLES / SCHREIBTISCHE UND TISCHE

1. TOP / TISCHPLATTE

natural veneer / Naturfurniere

- full colour according to BALMA colouring pattern / alle Farben des BALMA Materialmuster
- 10% additional payment / Aufpreis +10%
 - milk oak / Milcheiche 4544
 - cacao oak / Kakaoeiche 4545
 - coffee oak / Kaffeeeiche 4546

2. FULL LEG / WANGENFUß

natural veneer / Naturfurniere

- full colour according to BALMA colouring pattern / alle Farben des BALMA Materialmuster
- 10% additional payment / Aufpreis +10%
 - milk oak / Milcheiche 4544
 - cacao oak / Kakaoeiche 4545
 - coffee oak / Kaffeeeiche 4546

3. FRONT SHIELD / Knieblende

natural veneer / Naturfurniere

- full colour according to BALMA colouring pattern / alle Farben des BALMA Materialmuster
- 10% additional payment / Aufpreis +10%
 - milk oak / Milcheiche 4544
 - cacao oak / Kakaoeiche 4545
 - coffee oak / Kaffeeeiche 4546

CABINETS AND PEDESTALS / SCHRÄNKE UND CONTAINER

4. BODY / KORPUS

natural veneer / Naturfurniere

- full colour according to BALMA colouring pattern / alle Farben des BALMA Materialmuster
- 10% additional payment / Aufpreis +10%
 - milk oak / Milcheiche 4544
 - cacao oak / Kakaoeiche 4545
 - coffee oak / Kaffeeeiche 4546

glossy varnished MDF mat / MDF lackiert Struktur

- glossy white / Weiß Hochglanz N
- glossy black / Schwarz Hochglanz P
- glossy sand / Glänzendes Sand TP
- IMPORTANT: glossy lacquer only on right sides and edges; right side of backwall semi mat laquer, left sides and insides semi mat laquer / WICHTIG! Außenseite und Kanten - Glanzlack, Rückwand - Halbmatt; Innen - Halbmatt

glass / Glas

- satinato
- graphite / graphit 073

5. FRONT / FRONTEN

natural veneer / Naturfurniere

- full colour according to BALMA colouring pattern / alle Farben des BALMA Materialmuster
- 10% additional payment / Aufpreis +10%
 - milk oak / Milcheiche 4544
 - cacao oak / Kakaoeiche 4545
 - coffee oak / Kaffeeeiche 4546

glossy varnished MDF mat / MDF lackiert Struktur

- glossy white / Weiß Hochglanz N
- glossy black / Schwarz Hochglanz P
- glossy sand / Glänzendes Sand TP
- IMPORTANT: glossy lacquer only on right sides and edges; right side of backwall semi mat laquer, left sides and insides semi mat laquer / WICHTIG! Außenseite und Kanten - Glanzlack, Rückwand - Halbmatt; Innen - Halbmatt

glass / Glas

- satinato
- graphite / graphit 073

















PRICES / PREISE

STRAIGHT DESKS / GERADE SCHREIBTISCHE							
VIEW AND PROJECTION OF THE OBJECT / ANSICHT DES OBJEKTS		DIMENSIONS (in cm) / ABMESSUNGEN (in cm)			CATALOGUE NUMBER / PRODUKT-SYMBOL	NET PRICE in EUR / NETTOPREIS in €	REMARKS / BEMERKUNGEN
		WIDTH / BREITE	DEPTH / TIEFE	HEIGHT / HÖHE			
		200	100	74	I-01	1 109	straight desk with panel legs / Schreibtisch mit Wangenfüßen
		180	90	74	I-02	998	
		160			I-03	916	
		200	100/130	74	I-04	2 141	pedestal may be assembled on the right or left hand site / Schreibtisch mit Rollcontainer (Materialauszug, 3 Schubladen, Rechts oder Links)
		180	90/125		I-05	2 029	
		200	100/130	74	I-38	2 141	straight desk supported on a pedestal (1 drawer with suspension files frame, 1 drawer and a pencil case), metal inserts and a central lock. Pedestal may be assembled on the right or left hand site / Schreibtisch mit Rollcontainer (Materialauszug, Schublade, Hängeregistratur), Rechts oder Links
		180	90/125		I-39	2 029	

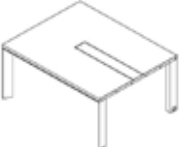
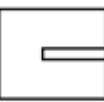
STRAIGHT DESKS / GERADE SCHREIBTISCHE								
VIEW AND PROJECTION OF THE OBJECT / ANSICHT DES OBJEKTS		DIMENSIONS (in cm) / ABMESSUNGEN (in cm)			CATALOGUE NUMBER / PRODUKT-SYMBOL	NET PRICE in EUR / NETTOPREIS in €		REMARKS / BEMERKUNGEN
		WIDTH / BREITE	DEPTH / TIEFE	HEIGHT / HÖHE		Desk and pedestal natura veneer / Schreibtisch und Container Natur Furnier	Desk veneer, pedestal glossy lacquer / Schreibtisch Natur furnier Container Glanzlack	
		200	100/175	74	I-42 RIGHT / RECHTS	3248	4016	straight desk supported on a cabinet (3 doors, upper part drawers), drawers inserts INNOTECH. Cabinet may be assembled on the right or left hand site. Pedestal I58 included. / Schreibtisch mit Schrank (3 Türen, Schubladen (Innotech) Rechts oder Links. Container I58 einbezogen.
					I-42 LEFT / LINKS			
		180	90/170		I-43 RIGHT / RECHTS	3191	3956	
					I-43 LEFT / LINKS			

PRICES / PREISE

CONFERENCE AND COFFEE TABLES / KONFERENZTISCHE UND COUITSCHTISCH





VIEW AND PROJECTION OF THE OBJECT / ANSICHT DES OBJEKTS	DIMENSIONS (in cm) / ABMESSUNGEN (in cm)			CATALOGUE NUMBER / PRODUKTSYMBOL	NET PRICE in EUR / NETTOPREIS in €	REMARKS / BEMERKUNGEN	
	WIDTH / BREITE	DEPTH / TIEFE	HEIGHT / HÖHE				
		220	110	74	I-10	1 481	conference tables / Konferenztische
		200	100		I-44	1 414	
		180	90		I-45	1 349	
		135	135		I-46	1 262	
		100	100		I-11	998	
		80	80	60	I-12	765	coffee table / Coutschtisch
		120	80	35	I-13	806	coffee table / Coutschtisch
		150	120	74	I-33	2 698	end - module of a conference table. Left module. Power feeder included. To be set with I-34 or I-35. / Konferenztischelement, links zur Verbindung der Elemente I-34 oder I-35.
		150	120	74	I-34	2 740	middle - module of a conference table. Power lead included. To be set with I-33, I-34 and I-35. / Mittelteil zur Verbindung der Elemente I-33, I-34 oder I-35.
		150	120	74	I-35	2 698	end - module of a conference table. Right module. Power lead included. To be set with I-34 or I-33. / Konferenztischelement, rechts zur Verbindung der Elemente I-34 oder I-33.
		150	120	74	I-40	1 648	module of a conference table, without light, to be set with I-41. One edge ended with aluminium slat. / Element des Konferenztisches, ohne Beleuchtung, zur Verbindung mit I-41, eine Kante mit Aluminiumleiste.
		150	120	74	I-41	1 604	module of a conference table, without light, to be set with I-40 / Element des Konferenztisches, ohne Beleuchtung, zur Verbindung mit I-40

PRICES / PREISE



EXTENSIONS DESKS / ANSATZTISCHE						
VIEW AND PROJECTION OF THE OBJECT / ANSICHT DES OBJEKTS	DIMENSIONS (in cm) / ABMESSUNGEN (in cm)			CATALOGUE NUMBER / PRODUKT-SYMBOL	NET PRICE in EUR / NETTOPREIS in €	REMARKS / BEMERKUNGEN
	WIDTH / BREITE	DEPTH / TIEFE	HEIGHT / HÖHE			
	100	60	74	I-14	388	perpendicular, for desks I-01, I-02 and I-03. / Ansatz Tisch, Senkrecht
	100	100	74	I-15	716	lengthwise, for desks I-01, I-04 (on the other side of the container) / Ansatz Tisch entlang der Schreibtische I-01 sowie I-04 (auf der ggü. liegenden Seite zum Container)
	90	90	74	I-16	666	lengthwise, for desks I-02, I-03 and I-05 (on the other side of the container) / Ansatz Tisch entlang der Schreibtische I-02, I-03 sowie I-05 (auf der ggü. liegenden Seite zum Container)

CABINETS / SIDEBBOARD								
VIEW AND PROJECTION OF THE OBJECT / ANSICHT DES OBJEKTS	DIMENSIONS (in cm) / ABMESSUNGEN (in cm)			CATALOGUE NUMBER / PRODUKT-SYMBOL	NET PRICE in EUR / NETTOPREIS in €		REMARKS / BEMERKUNGEN	
	WIDTH / BREITE	DEPTH / TIEFE	HEIGHT / HÖHE		Natural veneer / furnier	glossy lacquer / Glanzlack		
		140	43	62	I-55 RIGHT / RECHTS	1637	2373	cabinet on castors, upper part drawers, inserts Innotech, castors with brakes. / Sideboard mit Flügeltür und Schubladen (Innotech), Rollen
					I-55 LEFT / LINKS			
		140	43	62	I-58 RIGHT / RECHTS	1637	2373	cabinet on the feet, upper part drawers, inserts Innotech. / Sideboard mit Schubladen (Innotech), Füßen
					I-58 LEFT / LINKS			

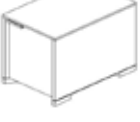

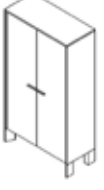

PRICES / PREISE

PEDESTALS / CONTAINER						
VIEW AND PROJECTION OF THE OBJECT / ANSICHT DES OBJEKTS	DIMENSIONS (in cm) / ABMESSUNGEN (in cm)			CATALOGUE NUMBER / PRODUKT-SYMBOL	NET PRICE in EUR / NETTOPREIS in €	REMARKS / BEMERKUNGEN
	WIDTH / BREITE	DEPTH / TIEFE	HEIGHT / HÖHE			
	43	65	59	I-25	731	3 drawers and pencil case / Container mit Materialauszug und 3 Schubladen
	43	65	59	I-31		pedestal with 2 drawers and a drawer with sliding frame for suspension files. / Container mit Materialauszug, Schublade, Hängeregistratur
	43	65	61	I-30	776	pedestal on castors with 3 drawers and pencil case / Rollcontainer mit Materialauszug und 3 Schubladen
	43	65	61	I-32		pedestal on castors with 2 drawers and a drawer with sliding frame for suspension files. / Rollcontainer mit Materialauszug, Schublade, Hängeregistratur
	43	65	59	I-26	486	right Tubing / Containerschrank, Rechts
	43	65	59	I-27		left Tubing / Containerschrank, Links

PRICES / PREISE

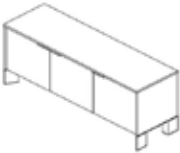
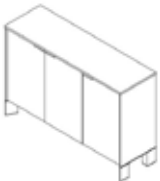

CABINETS / SCHRÄNKE							
VIEW AND PROJECTION OF THE OBJECT / ANSICHT DES OBJEKTS	DIMENSIONS (in cm) / ABMESSUNGEN (in cm)			CATA- LOGUE NUMBER / PRODUKT- SYMBOL	NET PRICE in EUR / NETTOPREIS in €		REMARKS / BEMERKUNGEN
	WIDTH / BREITE	DEPTH / TIEFE	HEIGHT / HÖHE		Natural veneer / furnier	glossy lacquer / Glanzlack	
	95	43	62	I-47	694	1 007	file cabinet / Hänge- registraturschrank
	95	43	93	I-48	878	1 271	file cabinet / Hänge- registraturschrank
	95	43	170	I-49	1 427	2 069	file cabinet 4OH / Hängeregistratur- schrank 4OH
	95	43	170	I-50	1 354	1 964	wardrobe 4OH / Garderobenschrank 4OH

PRICES / PREISE

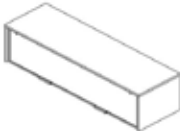
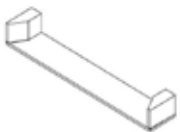
CABINETS / SCHRÄNKE							
VIEW AND PROJECTION OF THE OBJECT / ANSICHT DES OBJEKTS	DIMENSIONS (in cm) / ABMESSUNGEN (in cm)			CATALOGUE NUMBER / PRODUKT-SYMBOL	NET PRICE in EUR / NETTOPREIS in €		REMARKS / BEMERKUNGEN
	WIDTH / BREITE	DEPTH / TIEFE	HEIGHT / HÖHE		Natural veneer / furnier	glossy lacquer / Glanzlack	
	140	43	62	I-17	773	1 120	file cabinet / Hängeregistratur-schrank
	140	43	93	I-18	976	1 415	file cabinet / Hängeregistratur-schrank
	140	43	127	I-19	1 421	2 067	file cabinet, one part satinato glass / Hängeregistratur-schrank mit Glas
	140	43	170	I-20	1 916	2 779	
	140	43	170	I-21	1 589	2 305	file cabinet / Hängeregistratur-schrank
				I-22	1 508	2 187	wardrobe / Garderoben-schrank

SHELVES / HÄNGESCHRANK- UND REGAL							
	140	43	36	I-23	793	1150	hanging cabinet / Hänge-schrank mit Klappe
	140	25	17	I-24	229	not available / nicht verfügbar	hanging shelf / Hängeregal für Bücher o.ä.

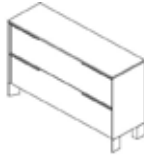

PRICES / PREISE
CABINETS WITH VERTICALLY OPENED DOORS / SCHRÄNKE MIT KLAPPENÖFFNUNG

VIEW AND PROJECTION OF THE OBJECT / ANSICHT DES OBJEKTS	DIMENSIONS (in cm) / ABMESSUNGEN (in cm)			CATA-LOGUE NUMBER / PRODUKT-SYMBOL	NET PRICE in EUR / NETTOPREIS in €				REMARKS / BEMER-KUNGEN
	WIDTH / BREITE	DEPTH / TIEFE	HEIGHT / HÖHE		Front glass, body natural veneer / Front Glas, korpus Furnier	Front glass, body glossy lacquer / Front Glas, korpus Glanz-lack	Front and body natural veneer / Front und korpus Furnier	Front and body glossy lacquer / Front und korpus Glanz-lack	
	140	43	92	I-53	1 749	2 487	1 317	1 910	
	140	43	127	I-54	2 415	3 501	1 823	2 644	









OPEN CABINET / REGALE

VIEW AND PROJECTION OF THE OBJECT / ANSICHT DES OBJEKTS	DIMENSIONS (in cm) / ABMESSUNGEN (in cm)			CATA-LOGUE NUMBER / PRODUKT-SYMBOL	NET PRICE in EUR / NETTOPREIS in €	REMARKS / BEMERKUNGEN
	WIDTH / BREITE	DEPTH / TIEFE	HEIGHT / HÖHE			
	140	43	93	I-51	991	
	140	43	127	I-52	1231	









FRONT SHIELDS / KNIEBLENDEN

	143	2,5	25	I-06	152	for assembling to desk I-04 / zum Schreibtisch I-04
	123	2,5	25	I-07	138	for assembling to desk I-05 / Zum Schreibtisch I-05

THE VALUATION OF IN RANGE BASED ON VISUALIZATION OF PRODUKT TYPES INCLUDED IN THE CATALOGUE / PREISE GEMÄSS PRODUKTKATALOG

CATALOGUE PAGE / KATALOGSEITE	FINISHING MATERIAL / OBERFLÄCHEN		NET PRICE in EUR / NETTOPREIS in €
3	I-04 Natural veneer – walnut stained in we-nige 4147 / Furnier – Nuss auf Wenge 4147		2141
4-5	I-42 Cabinet: glossy white N Desk: natural veneer – natural walnut 4100 / Schrank: Lack Hochglanz – weiß N / Schreibtisch: Furnier – Nuss natur 4100		5437
	I-19 Natural veneer - natural walnut 4100 / Furnier – Nuss natur 4100		
6-7	I-02 Natural veneer – american cherry 4243 / Furnier – americkanische Kirsche 4243		5808
	I-14 Natural veneer – american cherry 4243 / Furnier – americkanische Kirsche 4243		
	2x I-17 Natural veneer – american cherry 4243 / Furnier – americkanische Kirsche 4243		
	2x I-24 Natural veneer – american cherry 4243 / Furnier – americkanische Kirsche 4243		
	I-19 Natural veneer – american cherry 4243 / Furnier – americkanische Kirsche 4243		
	I-11 Natural veneer – american cherry 4243 / Furnier – americkanische Kirsche 4243		









PRICES / PREISE

CATALOGUE PAGE / KATALOGSEITE	FINISHING MATERIAL / OBERFLÄCHEN		NET PRICE in EUR / NETTOPREIS in €
8-9	I-10 Natural veneer – walnut stained in we- nige 4147 / Furnier – Nuss auf Wenge 4147		3854
	I-55 High glossy – light brown O (not available) / Lack Hochglanz – Braun hell O (nicht verfügbar)		
10	I-04 Natural veneer – american walut 4142 / Furnier – amerikanischer Nuss 4142		2141
11	I-01 Natural veneer – american walut 4142 / Furnier – amerikanischer Nuss 4142		5520
	I-15 Natural veneer – american walut 4142 / Furnier – amerikanischer Nuss 4142		
	I-22 Natural veneer – american walut 4142 / Furnier – amerikanischer Nuss 4142		
	I-19 Natural veneer – american walut 4142 / Furnier – amerikanischer Nuss 4142		
	I-12 Natural veneer – american walut 4142 / Furnier – amerikanischer Nuss 4142		

PRICES / PREISE

CATALOGUE PAGE / KATALOGSEITE	FINISHING MATERIAL / OBERFLÄCHEN	NET PRICE in EUR / NETTOPREIS in €
12-13	I-04 Natural veneer – american walut 4142 / Furnier – amerikanischer Nuss 4142	6487
	2x I-18 Natural veneer – american walut 4142 / Furnier – amerikanischer Nuss 4142	
	2x I-23 Natural veneer – american walut 4142 / Furnier – amerikanischer Nuss 4142	
	I-13 Natural veneer – american walut 4142 / Furnier – amerikanischer Nuss 4142	
14-15	I-46 Natural veneer – walnut stained in we-nige 4147 / Furnier – Nuss auf Wenge 4147	7407
	2x I-54 1. body: high glossy – glossy black P Front: foiled glass – graphite 073 2. body: high glossy – glossy black P Front: high glossy – glossy black P / 1. Korpus: Lack Hochglanz, Schwarz P / Front: Glas mit Folie, grafit 073 / 2. Korpus: Lack Hochglanz, Schwarz P / Front: Lack Hochglanz, Schwarz P	

PRICES / PREISE

CATALOGUE PAGE / KATALOGSEITE	FINISHING MATERIAL / OBERFLÄCHEN		NET PRICE in EUR / NETTOPREIS in €
16	I-33 Natural veneer - natural walut 4100 / Furnier – Nuss natur 4100		6784
	I-35 Natural veneer - natural walut 4100 / Furnier – Nuss natur 4100		
	2x I-37		
	2x I-36		
17	I-33 Natural veneer - natural walut 4100 / Furnier – Nuss natur 4100		9523
	I-34 Natural veneer - natural walut 4100 / Furnier – Nuss natur 4100		
	I-35 Natural veneer - natural walut 4100 / Furnier – Nuss natur 4100		
	2x I-37		
	2 x I-36	