



Counters  
Theken

# FURONTO

Counters  
Rezeptionsthekensystem

design: Piotr Kuchciński

The new system of modular reception counters is designed to satisfy the needs of demanding customers who look for modern, refined and customer-friendly appearance of their offices. The most conspicuous feature of the new counters, making them unique among the broad offer of the competition, is the lowered front in the standard version, showing the receptionist's face, thus facilitating interpersonal contact. Such a form of the furniture communicates openness, integrity and hospitality of the company. Wide range of basic elements of the system enables the reception space to be arranged freely and flexibly depending on your needs. Functional and aesthetic features of the new counters are enriched with accessories — 4 types of top boxes and shelves to choose from: board top boxes, light portable front top boxes, glass shelves on a steel leg and glass partitions.

Das neue-System Empfangstheken wurde für anspruchsvolle Kunden entworfen, die nach einer modernen, ungewöhnlichen und kundenfreundlichen Visitenkarte des Hauses suchen. Das charakteristische Merkmal der neuen Theken, das sie in dem Wettbewerbsangebot auszeichnet, ist die niedrigere Front in der Grundversion. So ist das Gesicht der Empfangsperson sichtbar und der persönliche Kontakt ist erleichtert. Eine solche Form der Theke kommuniziert Offenheit, Aufrichtigkeit und Gastfreundlichkeit des Unternehmens. Breite Wahl an Hauptelementen des Systems ermöglicht, je nach Bedarf, eine freie und flexible Gestaltung des Empfangsraumes. Die Funktionalität und die Ästhetik der neuen Theken werden durch Zubehör ergänzt – zur Wahl stehen 4 Typen von Tischaufsätzen und Fächern, leichte, verschiebbare Frontaufsätze Glasplatte auf Stahlbein und eine Trennwand aus Glas.



## COLLECTION ELEMENTS / ELEMENTE DER KOLLEKTION

COUNTERS / THEKEN				
WORKING DESK / TISCHPLATTE	melamine / Melaminplatte			
	thickness of working desk 25 mm; depth of working desk 60 or 80 cm – to choose / Plattenstärke 25 mm; Tiefe der TISCHPLATTE 60 oder 80 cm;			
FRONT / FRONTEN - STRAIGHT / - GERADE	Version 1 melamine / Melaminplatte	Version 2 natural veneer / Furnier	Version 3 Varnished MDF high glossy / MDF lackiert glanz	Version 4 Varnished MDF mat / MDF lackiert Struktur
	Version 5 HPL extra: beton / Beton	Version 6 HPL extra: stone / Stein	Version 7 natural veneer extra / Furnier extra	Version 8 glass / Glas
	thickness of front 50 mm; tempered glass varnished 8mm+distance 20mm / Plattenstärke 50 mm; Hartglas 8mm+Abstand 20mm			
FRONT / FRONTEN – CURVED MODULE / - GEBOGEN	Version 1 HPL	Version 2 natural veneer / Furnier		Version 4 Varnished MDF mat / MDF lackiert Struktur
	Version 5 HPL extra: beton / Beton	Version 6 HPL extra: stone / Stein	Version 7 natural veneer extra / Furnier extra	
	to choose 45° or 90°; thickness of front 50 mm / Ausführung zur Auswahl 45° oder 90°; Frontstärke 50 mm			
CLOSING SIDE PANEL / WANGENFUSS	Version 1 melamine / Melaminplatte	Version 2 natural veneer / Furnier	Version 3 Varnished MDF high glossy / MDF lackiert glanz	Version 4 Varnished MDF mat / MDF lackiert Struktur
	Version 5 HPL extra: beton / Beton	Version 6 HPL extra: stone / Stein	Version 7 natural veneer extra / Furnier extra	
	closing sides panels in two variants: low and high; width 65 or 85 cm; thickness of side 50 mm / Wangenfüsse niedrig oder hoch; Breite 65 oder 85 cm; Plattenstärke 50 mm			
BOTTOM RING / SOCKEL	varnished MDF mat, colour deep grey; Assembled LED lights / MDF lackiert, Farbe grau; LED-Beleuchtung			
FRAME / GESTELL	with cable ducts; Powder painted steel: colour silver mat / mit Kabelkanälen: Metall pulverbeschichtet: Farbe Silber			

ACCESSORIES				
SHELVES / AUFSÄTZE F2-21/22/23/24	melamine board and natural veneer; thickness – 36mm / Melamin, Furnier; Plattenstärke – 36mm			
	F2-21/22 – LED lighting / mit LED-Beleuchtung • F2-23/24 without lighting / ohne Beleuchtung			
SHELVES / TABLAR F2-25	tempered glass / Hartglas – thickness / 8mm			
	stainless steel or powder painted – according to colouring chart Balma / Edelstahl oder Metall pulverbeschichtet - Mustermappe Balma			
UPPER PART / AUFSATZ F2-26	Version 1 body and front: natural veneer / Korpus: Furnier + Front: Furnier	Version 2 body and front: varnished MDF mat / Korpus: MDF lackiert Struktur + Front: MDF lackiert Struktur	Version 3 body: natural veneer + front: conglomerate / Korpus, Furnier + Front: conglomerate / Kunststein, Acryl	Version 4 body: varnished MDF mat + front: conglomerate / MDF lackiert Struktur, Furnier + Front: conglomerate / Kunststein, Acryl
	ATTENTION: price indicates the finishing of front / Achtung: Ausführung im Frontbereich bestimmt den Preis. • IMPORTANT: it is not possible in counters with glass / ACHTUNG! Nicht zum Theken mit Glasausführung			
GLASS PARTITIONS / GLASAUFSATZ F2-27/28/29	tempered glass with the milled edges - thickness 6 mm, Price for 1 pc / Hartglas mit abgeschrägten Kanten – Dicke 6 mm, Preis für 1 Stück			

## ADDITIONAL INFORMATION / ZUSÄTZLICHE INFORMATIONEN

All modules are equipped with level regulator, range 25 mm / Bodenausgleich 25 mm. Lighting counter – LED lighting – white cold light / leuchtung - LED, weißes, kaltes Licht Shelf frame F2-25 – profile of circular cross section stainless steel or powder painted – diameter 80 mm / Tablar F2-25 – Edelstahl oder Metall pulverbeschichtet, D-80 mm, Hartglas. Attention! In each unit two cableports are included. Please choose the position: left, right, center / Achtung! Bitte bei der Bestellung immer die Kabeldurchlässe (im Standard 2 Stück) angeben: Links, Rechts, Mitte und die Farbe (am Ende der Preisliste). Height of the front glass 98 cm / Höhe der Frontscheibe 98 cm. In glass counters board lath is painted any color as per Balma metal chart / bei Glastheken ist die Sockelleiste in beliebiger Farbe nach Balma Mustermappe

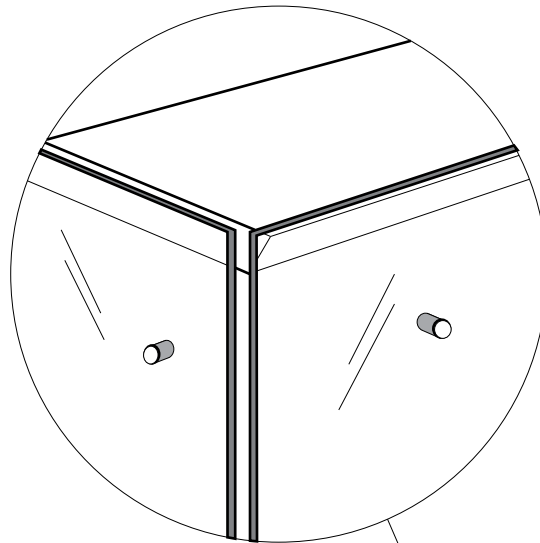

**1. FRONT / FRONTEN SIDE / WANGENFUSS**

- melamine / Melaminplatte
- natural veneer / Furnier
- natural veneer extra / Furnier extra
- HPL extra
- Varnished MDF mat / MDF lackiert Struktur
- Varnished MDF high glossy / MDF lackiert glanz

**2. DESKTOP / TISCHPLATTE**

- melamine / Melaminplatte

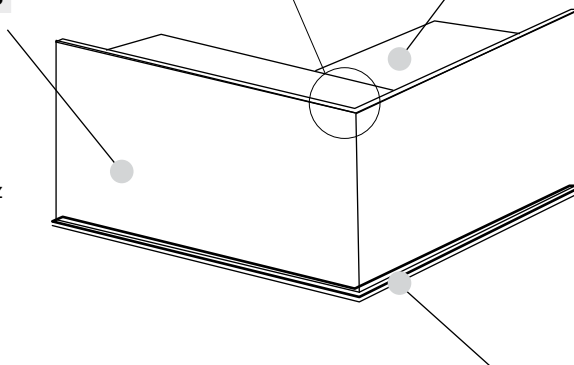

**4. BOTTOM RING / SOCKEL  
+ LED-BELEUCHTUNG**

**3. FRONT / FRONTEN**

- tempered glass / Hartglas

**2. DESKTOP / TISCHPLATTE**

- melamine / Melaminplatte

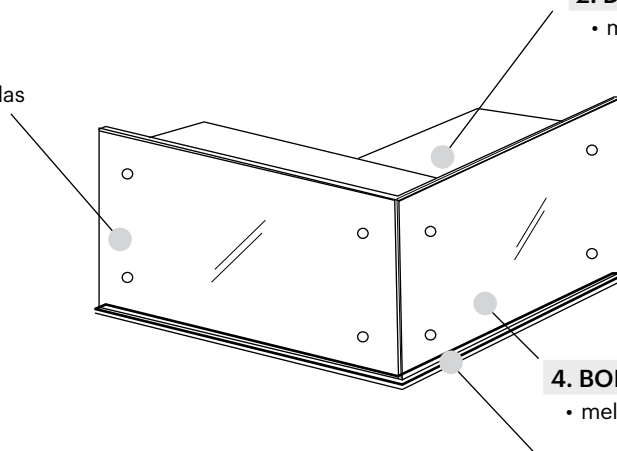

**4. BODY / KORPUS**

- melamine / Melaminplatte

**5. BOTTOM RING / SOCKEL  
+ LED-BELEUCHTUNG**

### 1. FRONT / FRONTEN SIDE / WAN- GENFUSS

melamine board / Melamin\*

- graphite / graphit 0300
- natural oak / Natureiche 0400
- light cherry / Helle Kirsche 0705
- grey / grau 1201
- deep grey / Tiefes Grau 1205
- true grey / echtes Grau 1208
- birch / Birke 1500
- black walnut / Schwarznuss 2380
- quartz / quartz 2424
- white / weiß 2700
- sand / Sand 2850
- acacia / Akazie 1520
- caramel walnut / Karamell Nuss 2360
- chocolate walnut / Schokoladen Nuss 2370
- caramel walnut / Karamell Nuss 2370

\* available for curved module - HPL laminate in colours according to melamine pattern / für das Bogenmodul - HPL in Farben, die auf die Platte melaminharzbeschichtet abgestimmt sind

\* for the side panel - HPL laminate on slim edge in colours according to melamine colour chart / für den Ansatz -HPL auf schmalen Kanten in Farben, die auf die Platte melaminharzbeschichtet abgestimmt sind

natural veneer / Naturfurniere

- full colour according to BALMA colouring pattern / alle Farben des BALMA Materialmuster
- 10% additional payment / Aufpreis +10%
  - milk oak / Milcheiche 4544
  - cacao oak / Kakaoeiche 4545
  - coffee oak / Kaffeeeiche 4546

natural veneer / Naturfurniere extra

- deeply pressed oak / zutiefst gepressten Eiche

HPL extra

- stone / Stein
- concrete / Beton

laquered MDF board / lackierte MDF Platten

- black mat / Matt schwarz B
- light grey / Lichtgrau E
- white mat / Matt weiß R
- new quartz / Neues Quartz S
- sand mat / Matt Sand TS
- deep grey / Tiefes Grau U
- dark graphite / Intensives Grafit W
- true grey / echtes Grau Z
- 10% additional payment / Aufpreis +10%
  - juicy green / Blattgrün Y
  - azure blue / Azurblau X

glossy laquered MDF board / lackierte MDF Platten\*

- glossy white / Weiß Hochglanz N
- glossy black / Schwarz Hochglanz P
- glossy sand / Glänzendes Sand TP

\*not available for curved modules / für das Bogenmodul nicht verfügbar

### 3. GLASS FRONT / GLAS FRONTEN

tempered glass / Hartglas

- clear satin
- graphite transparent

### 4. BODY / KORPUS (GLASS FRONT / GLAS FRONTEN)

melamine board / Melamin

- white / weiß 2700
- graphite / graphit 0300

### 2. DESKTOP / TISCHPLATTE

melamine board / Melamin

- graphite / graphit 0300
- natural oak / Natureiche 0400
- light cherry / Helle Kirsche 0705
- grey / grau 1201
- deep grey / Tiefes Grau 1205
- true grey / echtes Grau 1208
- birch / Birke 1500
- black walnut / Schwarznuss 2380
- quartz / quartz 2424
- white / weiß 2700
- sand / Sand 2850
- acacia / Akazie 1520
- caramel walnut / Karamell Nuss 2360
- chocolate walnut / Schokoladen Nuss 2370
- tuari / tuari 0900
- natural beech / Buche 0607\*
- black / schwarz 1100\*

\* not available for F2-03 / für F2-03 nicht verfügbar

### 5. BOTTOM RING + LED / SOCKEL + LED

BOTTOM RING / SOCKEL:

laquered MDF board / lackierte MDF Platten

- deep grey / Tiefes Grau U

BOTTOM RING / SOCKEL (GLASS FRONT / GLAS FRONTEN):

powder painted steel / Metall, pulverbeschichtet

- full colour according to BALMA colouring pattern / alle Farben des BALMA Materialmuster

LED:

cold white light / kaltweißem Licht

## 5. SHELVES / AUFSATZ F2-21/22/23/24

- melamine / Melaminplatte
- natural veneer / Furnier

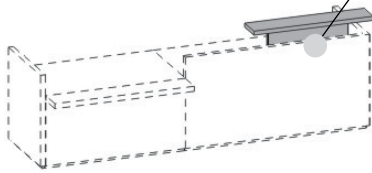

## 6. UPPER PART / AUFSATZ F2-26

- natural veneer / Furnier
- conglomerate / Kunststein, Acryl
- varnished MDF mat / MDF lackiert Struktur

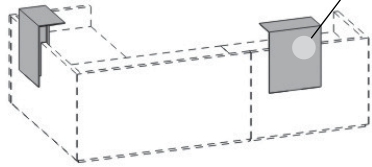

## 7. SHELF / TABLAR F2-25

- tempered glass / Hartglas

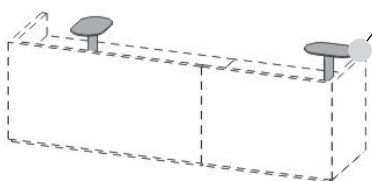

## 8. GLASS PARTITIONS / GLASAUFSATZ

- F2-27/28/29
- tempered glass / Hartglas

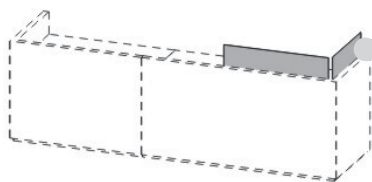

### 5. SHELVES / AUFSATZ F2-21/22/23/24

melamine board / Melamin

- graphite / graphit 0300
- natural oak / Natureiche 0400
- light cherry / Helle Kirsche 0705
- grey / grau 1201
- deep grey / Tiefes Grau 1205
- true grey / echtes Grau 1208
- birch / Birke 1500
- black walnut / Schwarznuss 2380
- quartz / quartz 2424
- white / weiß 2700
- sand / Sand 2850
- acacia / Akazie 1520
- caramel walnut / Karamell Nuss 2360
- chocolate walnut / Schokoladen Nuss 2370

natural veneer / Naturfurniere

- full colour according to BALMA colouring pattern / alle Farben des BALMA Materialmuster
- 10% additional payment / Aufpreis +10%
  - milk oak / Milcheiche 4544
  - cacao oak / Kakaoeiche 4545
  - coffee oak / Kaffeeeiche 4546

### 6. UPPER PART / AUFSATZ F2-26

natural veneer / Naturfurniere

- full colour according to BALMA colouring pattern / alle Farben des BALMA Materialmuster
  - 10% additional payment / Aufpreis +10%
    - milk oak / Milcheiche 4544
    - cacao oak / Kakaoeiche 4545
    - coffee oak / Kaffeeeiche 4546
- conglomerate / Kunststein, Acryl
- white / weiß

laquered MDF board / lackierte MDF Platten

- black mat / Matt schwarz B
- light grey / Lichtgrau E
- white mat / Matt weiß R
- new quartz / Neues Quartz S
- sand mat / Matt Sand TS
- deep grey / Tiefes Grau U
- dark graphite / Intensives Grafit W
- true grey / echtes Grau Z
- 10% additional payment / Aufpreis +10%
  - azure blue / Azurblau X
  - juicy green / Blattgrün Y

### 7. SHELF / TABLAR F2-25

tempered glass / Hartglas

- clear / Klarglas
- graphite / graphit

### 8. GLASS PARTITIONS / GLASAUF-SATZ

F2-27/28/29

tempered glass / Hartglas

- clear / Klarglas
- graphite / graphit

## PRICES / PREISE

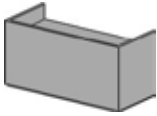
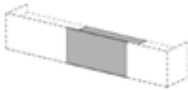
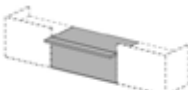
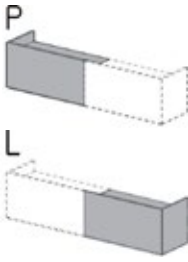
COUNTERS / THEKEN												
VIEW AND PROJECTION OF THE OBJECT / ANSICHT DES OBJEKTS	DIMENSIONS (in cm) / ABMESSUNGEN (in cm)			CATA-LOGUE NUMBER / PRO-DUKT-SYMBOL	NET PRICE in EUR / NETTOPREIS in €							
	WIDTH / BREITE	DEPTH / TIEFE	HEIGHT / HÖHE		melamine / Melamin-besch platten	natural veneer / Furnier	varnished MDF high glossy / MDF lackiert glanz	varnished MDF matt / MDF lackiert struktur	HPL extra: beton / HPL extra: Beton	HPL extra: stone / HPL extra: Stein	natural veneer extra / Furnier extra	glass* / Glas*
	130	65 or / oder 85	94	F2-01	1 314	1 734	2 497	1 714	7233	3 287	2 863	2 660
	150				1 372	1 839	2 678	1 845	7698	3 486	3 032	2 773
	170				1 431	1 949	2 876	1 988	7165	3 686	3 282	2 956
	190				1 488	2 064	3 088	2 142	8629	3 885	3 366	3 068
	210				1 546	2 187	3 316	2 308	9094	4 084	3 534	3 179
	120	65 or / oder 85	72/94	F2-02	882	1 088	1 518	1 065	3370	1 845	1 518	1 383
	140				928	1 176	1 674	1 178	3775	2 009	1 661	1 482
	160				972	1 271	1 846	1 303	4034	2 176	1 803	1 653
	180				1 018	1 370	2 033	1 439	4509	2 340	1 853	1 751
	200				1 064	1 476	2 236	1 586	4963	2 505	2 089	1 850
	120	89 or / oder 109	72	F2-03	996	1 196	1 680	1 180	2863	1 762	1 480	-
	140				1 047	1 290	1 844	1 300	3174	1 900	1 587	-
	160				1 114	1 406	2 046	1 446	3498	2 054	1 047	-
	180				1 166	1 510	2 241	1 588	3808	2 192	1 862	-
	200				1 217	1 620	2 452	1 741	4117	2 330	1 984	-
	125	65 or / oder 85	94	F2-04 (P) F2-05 (L)	1 104	1 418	2 017	1 396	5194	2 605	2 191	2 027
	145				1 163	1 522	2 194	1 525	5659	2 784	2 347	2 139
	165				1 221	1 631	2 388	1 665	6125	2 854	2 505	2 322
	185				1 279	1 745	2 597	1 817	6590	3 052	2 673	2 435
	205				1 337	1 866	2 820	1 979	7055	3 252	2 840	2 546

\*glass 8 mm + body:melamine + distance 20 mm, height of counter with glass 98 cm  
 \* Glas 8 mm +Korpus:Melamin + Glasbefestigung 20 mm, Höhe der Tcheke mit Glasfront 98 cm



COUNTERS / THEKEN																			
VIEW AND PROJECTION OF THE OBJECT / ANSICHT DES OBJEKTS	DIMENSIONS (in cm) / ABMESSUNGEN (in cm)				CATALOGUE NUMBER / PRODUKT-SYMBOL	NET PRICE in EUR / NETTOPREIS in €													
	WIDTH A/B / BREITE A/B	WIDTH A/B / BREITE A/B	DEPTH / TIEFE	HEIGHT / HÖHE		melamine / Melamin-besch platten	natural veneer / Furnier	varnished MDF high glossy / MDF lackiert glanz	varnished MDF matt / MDF lackiert struktur	HPL extra: beton / HPL extra: Beton	HPL extra: stone / HPL extra: Stein	natural veneer extra / Furnier extra	glass* / Glas*						
	F2-06 (P)	F2-07 (L)			<b>F2-06 (R) F2-07 (L)</b>														
	125 / 125	125 / 125				1 342	1 741	2 495	1 740	6224	2 968	2 634	2 375						
	125 / 145	145 / 125				1 400	1 844	2 673	1 869	6688	3 171	2 800	2 488						
	125 / 165	165 / 125				1 458	1 953	2 866	2 009	7155	3 370	2 967	2 672						
	125 / 185	185 / 125				1 516	2 069	3 075	2 161	7620	3 569	3 136	2 783						
	125 / 205	205 / 125				1 575	2 188	3 299	2 323	8084	3 768	3 303	2 895						
	145 / 125	125 / 145				1 400	1 844	2 673	1 869	6688	3 171	2 800	2 488						
	145 / 145	145 / 145				1 458	1 948	2 851	1 998	7153	3 370	2 967	2 599						
	145 / 165	165 / 145				1 516	2 057	3 044	2 138	7620	3 569	3 135	2 783						
	145 / 185	185 / 145				1 575	2 172	3 253	2 290	8084	3 768	3 303	2 894						
	145 / 205	205 / 145				1 633	2 292	3 477	2 452	8549	3 967	3 470	3 007						
	165 / 125	125 / 165				1 458	1 953	2 866	2 009	7155	3 370	2 967	2 672						
	165 / 145	145 / 165				1 516	2 057	3 044	2 138	7620	3 569	3 135	2 783						
	165 / 165	165 / 165				1 575	2 166	3 238	2 279	8086	3 769	3 303	2 967						
	165 / 185	185 / 165				1 633	2 281	3 447	2 430	8551	3 968	3 470	3 078						
	165 / 205	205 / 165				1 691	2 401	3 670	2 593	9016	4 166	3 638	3 191						
	185 / 125	125 / 185				1 516	2 057	3 044	2 138	7620	3 569	3 135	2 783						
	185 / 145	145 / 185				1 575	2 172	3 253	2 290	8084	3 768	3 303	2 894						
	185 / 165	165 / 185				1 633	2 281	3 447	2 430	8551	3 968	3 470	3 078						
	185 / 185	185 / 185				1 691	2 396	3 656	2 581	9016	4 166	3 638	3 191						
	185 / 205	205 / 185				1 749	2 516	3 879	2 745	9480	4 366	3 805	3 302						
	205 / 125	125 / 205				1 575	2 188	3 299	2 323	8084	3 768	3 303	2 895						
	205 / 145	145 / 205				1 633	2 292	3 477	2 452	8549	3 967	3 470	3 007						
	205 / 165	165 / 205				1 691	2 401	3 670	2 593	9016	4 166	3 638	3 191						
	205 / 185	185 / 205				1 749	2 516	3 879	2 745	9480	4 366	3 805	3 302						
	205 / 205	205 / 205				1 808	2 636	4 103	2 907	9945	4 565	3 973	3 414						

\*glass 8 mm + body:melamine + distance 20 mm, height of counter with glass 98 cm



\* Glas 8 mm +Korpus:Melamin + Glasbefestigung 20 mm, Höhe der Tcheke mit Glasfront 98 cm

## PRICES / PREISE

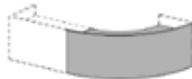
### CURVED MODULES / THEKE GEBOGEN

VIEW AND PROJECTION OF THE OBJECT / ANSICHT DES OBJEKTS	DIMENSIONS (in cm) / ABMESSUNGEN (in cm)			CATALOGUE NUMBER / PRODUKT-SYMBOL	NET PRICE in EUR / NETTOPREIS in €							
	WIDTH / BREITE	DEPTH / TIEFE	DEPTH / TIEFE		HPL / HPL	natural veneer / Furnier	varnished MDF high glossy / MDF lackiert glanz	varnished MDF matt / MDF lackiert struktur	HPL extra: beton / HPL extra: Beton	HPL extra: stone / HPL extra: Stein	natural veneerextra / Furnierextra	glass / Glas
	116 (45°)	65 or / oder 85	94	<b>F2-08</b>	1 202	1 311	-	1 367	4425	2 416	1 777	-
	214 (90°)				1 546	1 716	-	1 609	6980	3 496	2 644	-

### SIDE PANEL / WANGENFUSS



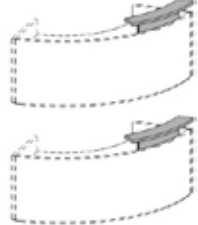
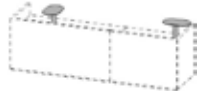
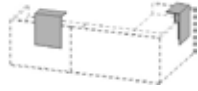
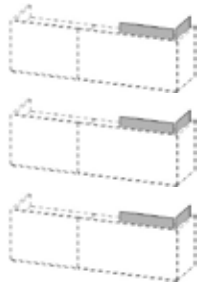
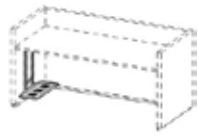

VIEW AND PROJECTION OF THE OBJECT / ANSICHT DES OBJEKTS	DIMENSIONS (in cm) / ABMESSUNGEN (in cm)			CATALOGUE NUMBER / PRODUKT-SYMBOL	NET PRICE in EUR / NETTOPREIS in €							
	WIDTH / BREITE	DEPTH / TIEFE	HEIGHT / HÖHE		melamine / Melamin-besch platten	natural veneer / Furnier	varnished MDF high glossy / MDF lackiert glanz	varnished MDF matt / MDF lackiert struktur	HPL extra: beton / HPL extra: Beton	HPL extra: stone / HPL extra: Stein	natural veneerextra / Furnierextra	HPL / HPL
	5	65 or / oder 85	72	<b>F2-09 (P) OR / ODER F2-10 (L)</b>	266	342	483	310	1251	428	386	-
			94	<b>F2-09(P) OR / ODER F2-10(L)</b>	285	369	549	343	1364	725	464	686

AKCESORIA									
VIEW AND PROJECTION OF THE OBJECT / ANSICHT DES OBJEKTS	DIMENSIONS (in cm) / ABMESSUNGEN (in cm)			CATALOGUE NUMBER / PRODUKT-SYMBOL	NET PRICE in EUR / NETTOPREIS in €				
	WIDTH / BREITE	DEPTH / TIEFE	HEIGHT / HÖHE		melamine / Melamin-besch platten	natural veneer / Furnier	varnished MDF matt / MDF lackiert Struktur	conglomerate / Konglomerat	glass / Glas
	120	25	43	F2-21	254	352	-	-	-
	80			F2-22	151	194	-	-	-
	120	25	43	F2-23	163	210	-	-	-
	80			F2-24	102	123	-	-	-
	50	30	42	F2-25	-	-	-	-	252 Stainless steel column / Edelstahl
	55	28	55	F2-26	-	251	236	371	151 Powder painted column / Metall pulverbeschichtet
	60	-	37	F2-27	-	-	-	-	148
	80			F2-28	-	-	-	-	162
	100			F2-29	-	-	-	-	212
	26	55	58	F2-30			73		

The valuation of Furonto range based on visualization of produkt types included In the catalogue /  
Preise gemäß Produktkatalog

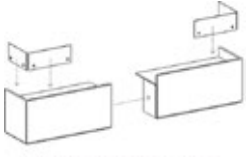
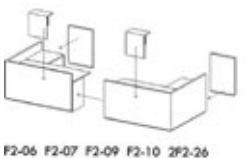
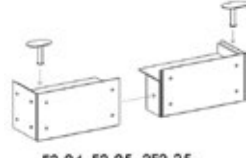
## PRICES / PREISE

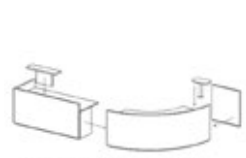
### THE VALUATION OF FURONTO RANGE BASED ON VISUALIZATION OF PRODUKT TYPES INCLUDED IN THE CATALOGUE / PREISE GEMÄSS PRODUKTKATALOG

TECHNICAL DRAWING	CATALOGUE PAGE / KATALOGSEITE	FINISHING MATERIAL / OBERFLÄCHEN	NET PRICE in EUR / NETTOPREIS in €
 <p>F2-04 F2-05 2F2-27 2F2-29</p>	2	F2-04, F2-05 Varnished MDF high glossy – glossy white N / MDF lackiert - glanzes weiss N	4753
		2F2-27, 2F2-29 Graphite glass / Glas grafit	
 <p>F2-06 F2-07 F2-09 F2-10 2F2-26</p>	4	F2-06, F2-07, F2-09, F2-10 HPL extra – beton / HPL extra – beton	15890
		2F2-26 Conglomerate / Konglomerat	
 <p>F2-04 F2-05 2F2-25</p>	5	F2-04, F2-05 Melamine – white 2700 + colourless glass / melaminbesch. platten - weiss 2700 + Glas farblos	4578
		2F2-25 Stainless steel column, shelf colourless glass / Teil aus rostfreien Stahl, Einlegeboden - Glas farblos	
 <p>2F2-08 F2-09 F2-10 F2-23</p>	6	2F2-08, F2-09, F2-10 HPL - tuari O900 / HPL - tuari O900	4328
		F2-23 Melamine – black 1100 / melamin – Schwarz 1100	
 <p>F2-04 F2-08 F2-10 F2-22 F2-25</p>	7	F2-04, F2-08, F2-10 Natural veneer extra – deeply pressed oak / Furnier Extra Eiche tiefgeprägt - Eiche tiefgeprägt	4845
		F2-22 Melamine – natural walnut 2303 / melamin - naturnuss 2302	
		F2-22 Melamine – natural walnut 2303 / melamin - naturnuss 2302	
 <p>F2-08 F2-09 F2-10 F2-25</p>	7	F2-08, F2-09, F2-10 Natural veneer – natural walnut 4100 / Furnier - naturnuss 4100	2312
		F2-25 Stainless steel column, shelf colourless glass / Teil aus rostfreien Stahl, Einlegeboden - Glas farblos	
 <p>2F2-03 F2-09 F2-10 F2-05 F2-21</p>	8-9	2F2-03, F2-09, F2-10, F2-05 Varnished MDF high glossy – glossy black P / MDF lackiert - MDF lackiert schwarz P	6576
		F2-21 Melamine – black 1100 / Melamin – Schwarz 1100	

NOTE: Valuations are based on the smallest available modules /  
HINWEIS: die genannten Preise gelten für die kleinsten Module