



Executive furniture and workstations Chefzimmer und Arbeitsplätze

MIXT

System of executive furniture and workstations
Chefzimmer und Arbeitsplätze

design: Piotr Kuchciński

New collection of modern furniture characterised by restrained form and a great selection of finish materials as well as module sizes, gives the buyers extraordinary freedom (and responsibility) in creating the space of their dreams. Extremely different arrangements can be achieved by using the same furniture in different options. The customer himself can determine the function of the room, its character, style, atmosphere, nobility. All the colours of materials have been chosen to match. The result is a possibility of unlimited experimenting in composing.

Eine neue moderne Möbelkollektion, die durch ihre ansprechenden Formen und dank ihrer großen Auswahl an Materialien, der Fertigung und der Größe der Module dem Benutzer eine ungemeine Freiheit in der Gestaltung seines eigenen ausgewählten Raumes gibt. Unter Einsetzung derselben Möbelstücke erlaubt dies eine Vielzahl an Möglichkeiten in der Bildung verschiedenster Zusammenstellungen. Der Kunde kann eigenhändig über die Funktion des Raumentwurfs, des Charakters, des Stils, der Beschaffenheit des Raumes entscheiden. Alle Farben aller Materialien wurden derart ausgewählt, dass sie miteinander harmonisieren. Dies gibt die unbegrenzte Möglichkeit beim Experimentieren.

COLLECTION ELEMENTS / ELEMENTE DER KOLLEKTION

EXECUTIVE DESKS / CHEFZIMMERSCHREIBTISCHE

DESKTOP / TISCHPLATTE	Version 1 natural veneer / Furnier	Version 2 foil / Folie PVC	Version 3 melamine / Melaminplatte
	25 mm chipboard, covered with natural veneer / MDF-Platte 25mm, Furnier	25 mm MDF board covered with PVC foil / MDF Stärke 25mm mit PVC Folie	25 mm melamine chipboard (MFC), PVC edging / Melaminplatte 25mm, PVC-Kanten
FRAME / GESTELL	frame stands out behind the desktop, rounded corners R20 / Gestell über den Tisch, Kanten abgerundet R-20		
	steel profile 80x20mm, powder painted / Metall 80x20mm, pulverbeschichtet		
	under the desktop metal frame 60x20mm, powder painted / Traverse, Metall 60x20mm, pulverbeschichtet		
FOOT / FUSS	Version 1 runner – horizontal level adjusting in range of 10 mm / Kufe – Niveaueausgleich 10mm	Version 2 single leg ended with a chrome foot, horizontal level adjusting in range of 20 mm / Einzelfuß abgerundet mit einem verchromten Fußaufsatz, Niveaueausgleich 20 mm	

WORKSTATION DESKS / SCHREIBTISCHE

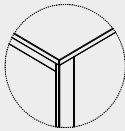
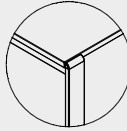
DESKTOP / TISCHPLATTE	Version 1 melamine / Melaminplatte	Version 1 foil / Folie PVC
	25 mm melamine chipboard (MFC) / Melamin 25 mm	25 mm MDF board covered with PVC foil / MDF Stärke 25mm mit PVC Folie
FRAME / GESTELL	Version 1 frame hidden under the desktop / Gestell unter dem Schreibtische	Version 2 frame stands out behind the desktop, rounded corners R20 / Gestell über den Tisch, Kanten abgerundet R-20
		
	steel profile 80x20 mm, powder painted / Metall 80x20 mm, pulverbeschichtet	
	under the desk cable duct, powder painted / Kabelkanal unter der Tischplatte, pulverbeschichtet	
horizontal level adjusting in range of 10 mm / Niveaueausgleich 10 mm		
HEIGHT ADJUSTMENT / HÖHEVERSTELLUNG	for Version 1 of the frame - option: running height regulation in range 70-82 cm, more price +100 EUR per single desk with 2 runners / Bei dem Gestell Version 1 Höhenregelung 70-82 cm gegen Aufpreis von 100 EUR pro Tisch	

CONFERENCE TABLES / KONFERENZTISCHE

DESKTOP / TISCHPLATTE	Version 1 natural veneer / Furnier	Version 2 foil / Folie PVC	Version 3 melamine / Melaminplatte
	25 mm chipboard, covered with natural veneer / MDF-Platte 25mm, Furnier	25 mm MDF board covered with PVC foil / MDF Stärke 25mm mit PVC Folie	25 mm melamine chipboard (MFC), PVC edging / Melamin-Platte 25mm, PVC-Kanten
FRAME / GESTELL	steel profile 80x20 mm, powder painted / Metall 80x20mm, pulverbeschichtet		
	frame stands out behind the desktop, rounded corners R20 / Gestell über den Tisch, Kanten R20		
	single leg ended with a chrome foot, horizontal level adjusting in range of 20 mm / Einzelfuß abgerundet mit verchromten Fußaufsatz, Niveaueausgleich 20mm		
	runner – horizontal level adjusting in range of 10 mm / Kufe – Niveaueausgleich 10mm		

COLLECTION ELEMENTS / ELEMENTE DER KOLLEKTION

COFFEE TABLES / COUCHTISCHE	
DESKTOP / TISCHPLATTE	MDF board 12 mm, lacquered / MDF 12 mm, lackiert
FRAME / GESTELL	steel profile 60x6 mm, powder painted, without level adjusting, frame stands out behind the desktop, rounded corners R20 / Metall 60x6mm, pulverbeschichtet, ohne Niveaueingleich, Gestell über den Tisch, Kanten R5

MOBILE CABINETS / MOBILE MÖBEL CONTAINER				
BODY / KORPUS	18 and 25 mm melamine chipboard (MFC), top ring 25 mm / Melamin, Plattenstärke 18 und 25 mm, Abdeckplatte 25 mm			
BACK WALL / RÜCKWAND	18 mm melamine chipboard (MFC) / Melamin, Plattenstärke 18mm			
DRAWERS / SCHUBLADEN	silent system, metal sides of drawers (except from 10K03) / silent system, Metallschubladen, (außer 10K03)		pedestal 10K03 – metal drawers Hettich, blockade preventing from pulling more than one drawer / Container 10K03 – Metallschubladen Hettich, Ausziehsperre	
FRONT / FRONTEN	natural veneer / Furnier	Varnished MDF mat / MDF lackiert Struktur	foil / Folie PVC	melamine / Melaminplatte
	horizontal grain / Maserung horizontal			
HANDLES / GRIFFE	no handles, part of the drawers' front in the function of handle / ohne Griffe			

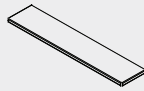
CABINETS / SCHRÄNKE UND REGALE						
BODY / KORPUS	18 and 25 mm melamine chipboard (MFC) / Melamin, Plattenstärke 18 und 25 mm					
BACK WALL / RÜCKWAND	18 mm melamine chipboard (MFC) / Melamin, Plattenstärke 18 mm					
SHELVES / FACHBÖDEN	25 mm melamine chipboard (MFC) / Melamin, Plattenstärke 25 mm					
TOP RING / ABDECKPLATTE	25 mm melamine chipboard (MFC), top mounted / Melamin, Plattenstärke 25mm		in hanging cabinets the top ring is inserted between the side panels / bei den Hängeschränken obere Abdeckung von oben eingelassen			
DRAWERS / SCHUBLADEN	silent system, metal sides of the drawers / silent system, Metallschubladen					
FRONT / FRONTEN	Version 1 natural veneer, horizontal layout of the grain / Furnier, horizontale Maserung	Version 2 glass in aluminium frame / Glas in Aluminiumrahmen	Version 3 upholstery in aluminium frame / Stoffbezug in Aluminiumrahmen	Version 4 varnished MDF mat / MDF lackiert Struktur	Version 5 PVC foil, horizontal layout of the grain, except for 4 OH (vertical) / PVC Folie, horizontale Maserung, mit Ausnahme 4OH - senkrecht	Version 6 melamine / Melaminplatte horizontal grain / Maserung horizontal
HANDLES / GRIFFE	fin_96: chrome / Chrom, hole spacing 96mm / Bohrungsabstand 96mm				flat_96, colour anodised aluminium / flach flat_96 Farbe Aluminium, hole spacing 96mm / Bohrungsabstand 96mm	
	other handles according to handle pricelist in ACCESSORIES / andere Griffe am Ende der Preisliste in ACCESSORIES					
BOTTOM RING / SOCKEL	bottom rings should be ordered separately / Sockel bitte separat bestellen					
	metal, powder painted / Metall, pulverbeschichtet					
	level adjustment: 20 mm / Bodenausgleich: 20 mm					
BOTTOM SLATS / SOCKELLEISTEN	polished aluminum / Aluminium poliert					

COLLECTION ELEMENTS / ELEMENTE DER KOLLEKTION

HANGING SHELF / HÄNGEREGAL

HANGING
SHELF 06K21 /
HÄNGEREGAL 06K21

lacquered mdf board, silver, vertical part mirror with satinato glass / MDF lackiert Farbe Silber,
senkrechter Teil Spiegel mit satiniertem Glas.

PARTITION SCREENS / TRENNWÄNDE

BODY / KORPUS

18 mm melamine chipboard, PVC edges / Melamin, Plattenstärke 18mm

FABRICS /
POLSTERUNG

NEXT according to PROFIM pattern / gemäß PROFIM Stoffmuster
HELICON according to NOTI pattern / gemäß NOTI Stoffmuster
AGAVA according to NOTI pattern - price+15% / gemäß NOTI Stoffmuster Aufpreis+15%

EXECUTIVE DESKS / CHEFZIMMERSCHREIBTISCHE
CONFERENCE TABLES / KONFERENZTISCHE

1. DESKTOP / TISCHPLATTE

- melamine / Melaminplatte
- natural veneer / Furnier
- foil / Folie

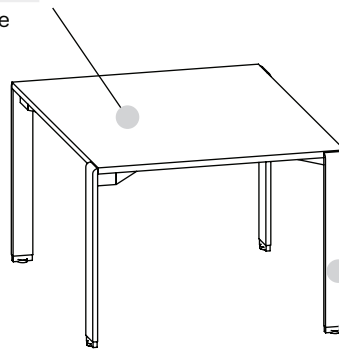

2. FRAME / GESTELL

- powder painted steel / Metall, pulverbeschichtet

4. CHROME LEG / FUSSE VERCHROMT

COFFEE TABLES / COUCHTISCHE

3. DESKTOP / TISCHPLATTE

- varnished MDF mat / MDF lackiert Struktur

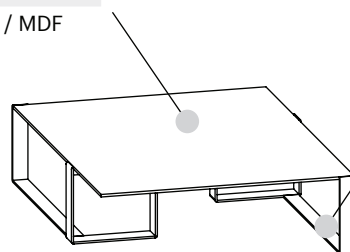

2. FRAME / GESTELL

- powder painted steel / Metall, pulverbeschichtet

EXECUTIVE DESKS / CHEFZIMMERSCHREIBTISCHE CONFERENCE TABLES / KONFERENZTISCHE

1. DESKTOP / TISCHPLATTE

melamine board / Melamin

- full colour according to BALMA colouring pattern / alle Farben des BALMA Materialmuster
- 10% additional payment / Aufpreis +10%
 - juicy green / Blattgrün 1750
 - azure blue / Azurblau 1850

natural veneer / Naturfurniere

- full colour according to BALMA colouring pattern / alle Farben des BALMA Materialmuster
- 10% additional payment / Aufpreis +10%
 - milk oak / Milcheiche 4544
 - cacao oak / Kakaoeiche 4545
 - coffee oak / Kaffeeeiche 4546

foil / Folie

- oak / Eiche 3600
- light walnut / helle Nuss 3200
- dark walnut / dunkle Nuss 3100

2. FRAME / GESTELL

powder painted steel / Metall, pulverbeschichtet

- dark graphite / Intensives Graphit RAL 7021
- new quartz / Neues Quartz RAL 7022
- deep grey / Tiefes Grau RAL 7037
- sand / Sand
- dark brown / Dunkelbraun RAL 8022
- white mat / Matt Weiß 9003
- black / Schwarz RAL 9005
- white satin / Weiß Satin 9016
- glossy silver / Silberglanz
- matt silver / Silbermatt
- azure blue / Azurblau
- juicy green / Blattgrün

COFFEE TABLES / COUCHTISCHE

2. FRAME / GESTELL

powder painted steel / Metall, pulverbeschichtet

- dark graphite / Intensives Graphit RAL 7021
- new quartz / Neues Quartz RAL 7022
- deep grey / Tiefes Grau RAL 7037
- sand / Sand
- dark brown / Dunkelbraun RAL 8022
- white mat / Matt Weiß 9003
- black / Schwarz RAL 9005
- white satin / Weiß Satin 9016
- glossy silver / Silberglanz
- matt silver / Silbermatt
- azure blue / Azurblau
- juicy green / Blattgrün

3. DESKTOP / TISCHPLATTE

varnished MDF mat / MDF lackiert
Struktur

- black mat / Matt Schwarz B
- light grey / Lichtgrau E
- white mat / Matt Weiß R
- new quartz / Neues Quartz S
- sand mat / Matt Sand TS
- deep grey / Tiefes Grau U
- dark graphite / Intensives Graphit W
- true grey / Echtes Grau Z
- 10% additional payment / Aufpreis +10%
 - azure blue / Azurblau X
 - juicy green / Blattgrün Y

FINISHING / AUSFÜHRUNG

WORKSTATION DESKS / SCHREIBTISCHE

1. DESKTOP / TISCHPLATTE

- melamine / Melaminplatte

2. FRAME / GESTELL

- powder painted steel / Metall, pulverbeschichtet

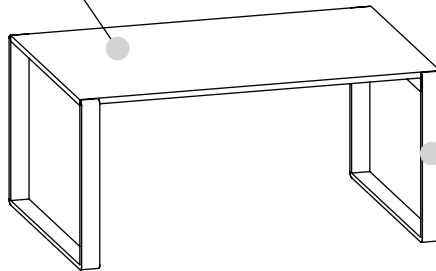

CABINETS / SCHRÄNKE UND REGALE

3. BODY / KORPUS

- melamine / Melaminplatte

4. FRONT / FRONTEN

- melamine / Melaminplatte
- foil / Folie
- varnished MDF mat / MDF lackiert Struktur
- natural veneer / Furnier
- glass in aluminium frame / Glas in Aluminiumrahmen
- upholstery in aluminium frame (in hanging cabinets) / Stoffbezogen, in Aluminiumrahmen

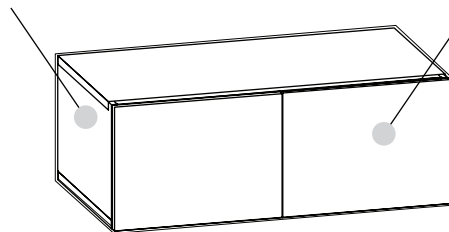

5. SLIDING DOOR / SCHIEBETÜR



- glass in aluminium frame / Glas in Aluminiumrahmen
- upholstery in aluminium frame / Stoffbezogen, in Aluminiumrahmen
- melamine / Melaminplatte

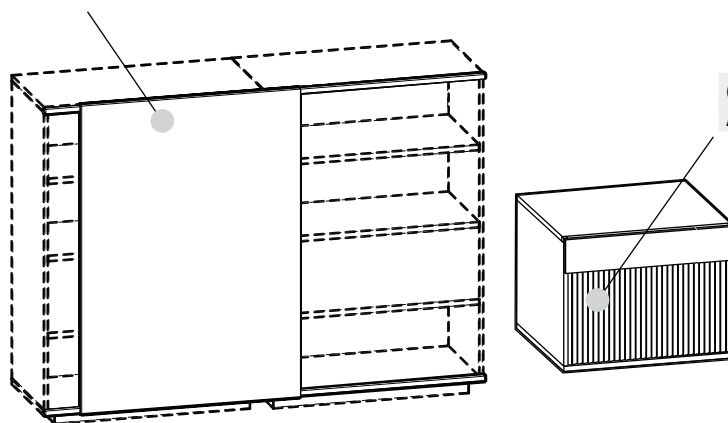

6. PCV TAMBOUR / PCV ROLLADE





WORKSTATION DESKS / SCHREIBTISCHE	CABINETS / SCHRÄNKE UND REGALE	
<p>1. DESKTOP / TISCHPLATTE</p> <p>melamine board / Melamin</p> <ul style="list-style-type: none"> • full colour according to BALMA colouring pattern / alle Farben des BALMA Materialmuster • 10% additional payment / Aufpreis +10% <ul style="list-style-type: none"> - juicy green / Blattgrün 1750 - azure blue / Azurblau 1850 <p>2. FRAME / GESTELL</p> <p>powder painted steel / Metall, pulverbeschichtet</p> <ul style="list-style-type: none"> - dark graphite / Intensives Graphit RAL 7021 - new quartz / Neues Quartz RAL 7022 - deep grey / Tiefes Grau RAL 7037 - sand / Sand - dark brown / Dunkelbraun RAL 8022 - white mat / Matt Weiß 9003 - black / Schwarz RAL 9005 - white satin / Weiß Satin 9016 - glossy silver / Silberglanz - matt silver / Silbermatt - azure blue / Azurblau - juicy green / Blattgrün 	<p>4. FRONT / FRONTEN</p> <p>melamine board / Melamin</p> <ul style="list-style-type: none"> • full colour according to BALMA colouring pattern / alle Farben des BALMA Materialmuster • 10% additional payment / Aufpreis +10% <ul style="list-style-type: none"> - juicy green / Blattgrün 1750 - azure blue / Azurblau 1850 <p>natural veneer / Naturfurniere</p> <ul style="list-style-type: none"> • full colour according to BALMA colouring pattern / alle Farben des BALMA Materialmuster • 10% additional payment / Aufpreis +10% <ul style="list-style-type: none"> - milk oak / Milcheiche 4544 - cacao oak / Kakaoeiche 4545 - coffee oak / Kaffeeeiche 4546 <p>foil / Folie</p> <ul style="list-style-type: none"> - oak / Eiche 3600 - light walnut / helle Nuss 3200 - dark walnut / dunkle Nuss 3100 <p>varnished MDF mat / MDF lackiert Struktur</p> <ul style="list-style-type: none"> - black mat / Matt Schwarz B - light grey / Lichtgrau E - white mat / Matt Weiß R - new quartz / Neues Quartz S - sand mat / Matt Sand TS - deep grey / Tiefes Grau U - dark graphite / Intensives Graphit W - true grey / Echtes Grau Z • 10% additional payment / Aufpreis +10% <ul style="list-style-type: none"> - azure blue / Azurblau X - juicy green / Blattgrün Y 	<p>5. SLIDING DOOR / SCHIEBETÜR</p> <p>glass in aluminum frame / Glas in Aluminiumrahmen</p> <ul style="list-style-type: none"> - graphite / Graphit 073 <p>upholstery / Stoff</p> <ul style="list-style-type: none"> - HELICON according to NOTI colours - AGAVA according to NOTI pattern - price+15% / gemäß NOTI Stoffmuster Aufpreis +15% <p>melamine board / Melamin</p> <ul style="list-style-type: none"> • full colour according to BALMA colouring pattern / alle Farben des BALMA Materialmuster • 10% additional payment / Aufpreis +10% <ul style="list-style-type: none"> - juicy green / Blattgrün 1750 - azure blue / Azurblau 1850 <p>3. BODY / KORPUS</p> <p>melamine board / Melamin</p> <ul style="list-style-type: none"> • full colour according to BALMA colouring pattern / alle Farben des BALMA Materialmuster • 10% additional payment / Aufpreis +10% <ul style="list-style-type: none"> - juicy green / Blattgrün 1750 - azure blue / Azurblau 1850 <p>6. PVC TAMBOUR / PVC ROLLADE</p> <p>plastic / Kunststoff</p> <ul style="list-style-type: none"> - silver / Silber - grey / Grau - black / Schwarz - anthracite / Anthrazit - white / Weiß

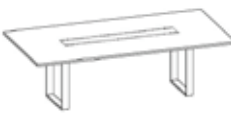

PRICES / PREISE

EXECUTIVE DESKS / CHEFZIMMERSCHREIBTISCHE								
VIEW AND PROJECTION OF THE OBJECT / ANSICHT DES OBJEKTS	DIMENSIONS (in cm) / ABMESSUNGEN (in cm)			CATALOGUE NUMBER / PRODUKT-SYMBOL	NET PRICE in EUR / NETTOPREIS in €			REMARKS / BEMERKUNGEN
	WIDTH / BREITE	DEPTH / TIEFE	HEIGHT / HÖHE		NATURAL VENEER / FURNIER	FOIL / FOLIE	MELAMINE / MELAMIN	
	200	100	74	02K01	1016	784	548	pencil case with socket outlet 14K28 is an option, should be ordered separately / mit Verstärkungsleiste als Option 14K28, bitte separat bestellen
	180			02K02	960	732	522	
	180	100	74	02K03	1009	777	593	
	160			02K04	950	727	549	



CONFERENCE TABLES / KONFERENZTISCHE								
	135	135	74	03K01	905	-	463	
	277	120	74	03K02	1278	-	637	lightning unit 14K29 is an option, should be ordered separately / Beleuchtetes Modul 14K29 als Option bitte separat bestellen
	234	120	74	03K03	1151	877	593	
	100	100	74	03K04	801	572	481	

COFFEE TABLES / COUITSCHTISCHE							
VIEW AND PROJECTION OF THE OBJECT / ANSICHT DES OBJEKTS	DIMENSIONS (in cm) / ABMESSUNGEN (in cm)			CATALOGUE NUMBER / PRODUKT-SYMBOL	NET PRICE in EUR / NETTOPREIS in €		REMARKS / BEMERKUNGEN
	WIDTH / BREITE	DEPTH / TIEFE	HEIGHT / HÖHE		LACQUERED MDF / MDF LACKIERT		
	100	100	30	03K05		421	
	140	50	40	03K06		336	
	50	50	50	03K07		247	



WORKSTATION DESKS – FRAME VERSION 1 / SCHREIBTISCHE – GESTELL VERSION 1

VIEW AND PROJECTION OF THE OBJECT / ANSICHT DES OBJEKTS	DIMENSIONS (in cm) / ABMESSUNGEN (in cm)			CATALOGUE NUMBER / PRODUKT-SYMBOL	NET PRICE in EUR / NETTOPREIS in €		REMARKS / BEMERKUNGEN
	WIDTH / BREITE	DEPTH / TIEFE	HEIGHT / HÖHE		MELAMINE / MELAMIN	FOIL / FOLIE	
	200	80	74	02K05-1A	352	477	straight desk, frame hidden under the desktop / Einzelschreibtisch, Gestell unter Platte versteckt
	180			02K06-1A	346	464	
	160			02K07-1A	335	454	
	140			02K08-1A	352	441	
	120			02K09-1A	318	428	
	200	160	74	02K10-1A	629	850	2-person workstation, frame hidden under the desktop, not possible to assemble partition walls / Doppelarbeitsplatz, Gestell unter Tischplatte. Keine Möglichkeit der Montage von Trennwänden.
	180			02K11-1A	611	824	
	160			02K12-1A	594	801	
	140			02K13-1A	577	777	
	120			02K14-1A	556	753	
	200	160	74	02K10-1C	629	850	2-person workstation, frame hidden under the desktop, desktops prepared for assembling partition walls / Doppelarbeitsplatz, Gestell unter Platte versteckt. Möglichkeit der Montage von Trennwänden.
	180			02K11-1C	611	824	
	160			02K12-1C	594	801	
	140			02K13-1C	577	777	
	120			02K14-1C	558	754	

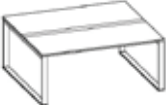
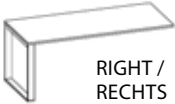

WORKSTATION DESKS – FRAME VERSION 2 / SCHREIBTISCHE – GESTELL VERSION 2

	200	80	74	02K05-1B	461	583	straight desk, frame stands out behind the desktop / Einzeltisch, Gestell steht über den Tischumriss
	180			02K06-1B	453	572	
	160			02K07-1B	442	560	
	140			02K08-1B	435	548	
	120			02K09-1B	425	537	
	200	160	74	02K10-1B	736	956	2-person workstation, frame stands out behind the desktop, not possible to assemble partition walls / Doppelarbeitsplatz, Gestell steht über den Tisch Keine Möglichkeit der Montage von Trennwänden
	180			02K11-1B	719	932	
	160			02K12-1B	701	908	
	140			02K13-1B	684	885	
	120			02K14-1B	666	862	



PRICES / PREISE

WORKSTATION DESKS – FRAME VERSION 2 / SCHREIBTISCHE – GESTELL VERSION 2							
VIEW AND PROJECTION OF THE OBJECT / ANSICHT DES OBJEKTS	DIMENSIONS (in cm) / ABMESSUNGEN (in cm)			CATALOGUE NUMBER / PRODUKT-SYMBOL	NET PRICE in EUR / NETTOPREIS in €		REMARKS / BEMERKUNGEN
	WIDTH / BREITE	DEPTH / TIEFE	HEIGHT / HÖHE		MELAMINE / MELAMIN	FOIL / FOLIE	
	200	160	74	02K10-1D	736	996	2-person workstation, frame stands out behind the desktop, desktops prepared for assembling partition walls / Doppelarbeitsplatz, Gestell steht über den Tisch. Möglichkeit der Montage von Trennwänden.
	180			02K11-1D	719	932	
	160			02K12-1D	701	908	
	140			02K13-1D	683	885	
	120			02K14-1D	666	862	
WORKSTATION DESKS – FRAME VERSION 1 / SCHREIBTISCHE – GESTELL VERSION 1							
 RIGHT / RECHTS	200	80	74	02K15-1A	278	402	straight desk, frame hidden under the desktop / Schreibtisch, Gestell unter Platte
	180			02K16-1A	270	391	
	160			02K17-1A	262	378	
	140			02K18-1A	252	367	
	120			02K19-1A	244	354	
	200	160	74	02K20-1A	517	737	2-person workstation, frame hidden under the desktop, not possible to assemble partition walls / Doppelarbeitsplatz, Gestell unter Tischplatte. Keine Möglichkeit der Montage von Trennwänden
	180			02K21-1A	499	713	
	160			02K22-1A	483	690	
	140			02K23-1A	465	666	
	120			02K24-1A	447	644	
	200	160	74	02K20-1C	517	737	2-person workstation, frame hidden under the desktop, desktops prepared for assembling partition walls / Doppelarbeitsplatz, Gestell unter der Platte. Möglichkeit der Montage von Trennwänden
	180			02K21-1C	499	713	
	160			02K22-1C	483	690	
	140			02K23-1C	465	666	
	120			02K24-1C	447	644	

WORKSTATION DESKS – FRAME VERSION 2 / SCHREIBTISCHE – GESTELL VERSION 2



VIEW AND PROJECTION OF THE OBJECT / ANSICHT DES OBJEKTS	DIMENSIONS (in cm) / ABMESSUNGEN (in cm)			CATALOGUE NUMBER / PRODUKT-SYMBOL	NET PRICE in EUR / NETTOPREIS in €		REMARKS / BEMERKUNGEN
	WIDTH / BREITE	DEPTH / TIEFE	HEIGHT / HÖHE		MELAMINE / MELAMIN	FOIL / FOLIE	
 RIGHT / RECHTS	200	80	74	02K15-1B	332	457	straight desk, frame stands out behind the desktop / Schreibtisch, Gestell steht über den Tisch.
	180			02K16-1B	324	443	
	160			02K17-1B	315	433	
	140			02K18-1B	306	420	
	120			02K19-1B	298	484	
	200	160	74	02K20-1B	571	792	2-person workstation, frame stands out behind the desktop, not possible to assemble partition walls / Doppelaarbeitsplatz, Gestell steht über den Tisch. Keine Möglichkeit der Montage von Trennwänden.
	180			02K21-1B	553	768	
	160			02K22-1B	537	745	
	140			02K23-1B	520	720	
	120			02K24-1B	501	696	
	200	160	74	02K20-1D	571	792	2-person workstation, frame stands out behind the desktop, desktops prepared for assembling partition walls / Doppelaarbeitsplatz, Gestell steht über den Tisch. Möglichkeit der Montage von Trennwänden
	180			02K21-1D	599	768	
	160			02K22-1D	537	745	
	140			02K23-1D	520	720	
	120			02K24-1D	501	696	

DESKS TO BUILD BENCH SYSTEM – FRAME VERSION 1 / ANBAUSCHREIBTISCHE – GESTELL VERSION 1





	200	80	9	02K15-0A	203	328	desktop without frame, with cable duct under the desktop, prepared for frame in version 1 / Tischplatte ohne Gestell mit Kabelkanal unter Tischplatte, angepasst für Gestell der Version 1.
	180			02K16-0A	195	316	
	160			02K17-0A	186	304	
	140			02K18-0A	179	292	
	120			02K19-0A	169	280	
	200	160	9	02K20-0A	406	626	desktops for a two-person workstation; without frame, with a cable duct under the desktop, prepared for frame in Version 1, not possible to assemble partition walls / Tischplatten Doppelaarbeitsplatz, ohne Gestell, angepasst für Gestell der Version 1. Keine Möglichkeit der Montage von Trennwänden.
	180			02K21-0A	390	603	
	160			02K22-0A	372	579	
	140			02K23-0A	354	555	
	120			02K24-0A	336	531	
	200	160	9	02K20-0C	406	626	desktops for a two-person workstation; without frame, with a cable duct under the desktop, prepared for frame in Version 1, desktops prepared for assembling partition walls / Tischplatten, Doppelaarbeitsplatz, ohne Gestell, angepasst für Gestell der Version 1. Möglichkeit der Montage von Trennwänden
	180			02K21-0C	390	603	
	160			02K22-0C	372	579	
	140			02K23-0C	354	555	
	120			02K24-0C	336	531	

PRICES / PREISE

DESKS TO BUILD BENCH SYSTEM – FRAME VERSION 2 / ANBAUSCHREIBTISCHE – GESTELL VERSION 2

VIEW AND PROJECTION OF THE OBJECT / ANSICHT DES OBJEKTS	DIMENSIONS (in cm) / ABMESSUNGEN (in cm)			CATALOGUE NUMBER / PRODUKT-SYMBOL	NET PRICE in EUR / NETTOPREIS in €)		REMARKS / BEMERKUNGEN
	WIDTH / BREITE	DEPTH / TIEFE	HEIGHT / HÖHE		MELAMINE / MELAMIN	FOIL / FOLIE	
	200	76	9	02K15-OB	203	328	desktop without frame, with cable duct under the desktop, prepared for frame in version 2 / Tischplatte, ohne Gestell mit Kabelkanal unter Tischplatte, angepasst für Gestell der Version 2.
	180			02K16-OB	195	316	
	160			02K17-OB	186	304	
	140			02K18-OB	179	292	
	120			02K19-OB	169	280	
	200	156	9	02K20-OB	406	626	desktops for a two-person workstation; without frame, with a cable duct under the desktop, prepared for frame in Version 2, not possible to assemble partition walls / Tischplatten, Doppelarbeitsplatz, ohne Gestell, angepasst für Gestell der Version 2. Keine Möglichkeit der Montage von Trennwänden.
	180			02K21-OB	390	603	
	160			02K22-OB	372	579	
	140			02K23-OB	354	555	
	120			02K24-OB	336	531	
	200	156	9	02K20-OD	406	626	desktops for a two-person workstation; without frame, with a cable duct under the desktop, prepared for frame in Version 2, desktops prepared for assembling partition walls / Tischplatten, Doppelarbeitsplatz, ohne Gestell, angepasst für Gestell der Version 2. Möglichkeit der Montage von Trennwänden.
	180			02K21-OD	390	603	
	160			02K22-OD	372	579	
	140			02K23-OD	354	555	
	120			02K24-OD	336	531	



EXTENSION LEGS – FRAME VERSION 1 / SCHREIBTISCHKUFEN – GESTELL VERSION 1

VIEW AND PROJECTION OF THE OBJECT / ANSICHT DES OBJEKTS	DIMENSIONS (in cm) / ABMESSUNGEN (in cm)			CATALOGUE NUMBER / PRODUKT-SYMBOL	NET PRICE in EUR / NETTOPREIS in €)	REMARKS / BEMERKUNGEN
	WIDTH / BREITE	DEPTH / TIEFE	HEIGHT / HÖHE			
	80	8	72	14K30-A	97	extension leg for bench system – for desks 02K15 – 02K19, frame Version 1 – hidden under the desktop / Mittelkufe zum Anbau von Schreibtischen Typ 02K15 – 02K19. Gestell Version 1 – ganz unter der Schreibtischplatte eingerückt.
	160	8	72	14K31-A	139	extension leg for bench system - for desks 02K20 – 02K24, frame Version 1 – hidden under the desktop / Mittelkufe zum Anbau von Schreibtischen Typ 02K20 – 02K24. Gestell Version 1 – ganz unter der Schreibtischplatte eingerückt
	67	8	72	14K33	123	recessed middle leg for bench desks – frame version A and B / Mittelstützfuss zur Verbindung der Tische A und B
	67	1,5	62	14K35	146	

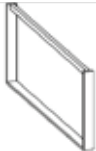
EXTENSION LEGS – FRAME VERSION 2 / SCHREIBTISCHKUFEN – GESTELL VERSION 2

VIEW AND PROJECTION OF THE OBJECT / ANSICHT DES OBJEKTS	DIMENSIONS (in cm) / ABMESSUNGEN (in cm)			CATALOGUE NUMBER / PRODUKT-SYMBOL	NET PRICE in EUR / NETTOPREIS in €	REMARKS / BEMERKUNGEN
	WIDTH / BREITE	DEPTH / TIEFE	HEIGHT / HÖHE			
	80	8	72	14K30-B	129	extension leg for bench system – for desks 02K15 – 02K19, frame version 2 – frame stands out behind the desktop / Mittlere Kufe zum Anbau an Schreibtische 02K15 – 02K19. Gestell Version 2. Überstand zum Tischemriss
	160	8	72	14K31-B	166	extension leg for bench system – for desks 02K20 – 02K24, frame version 2 – frame stands out behind the desktop / Mittlere Kufe zum Anbau an Schreibtische 02K20 – 02K24. Gestell Version 2 – Überstand zum Tischemriss.

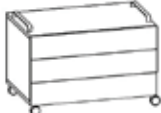

MOBILE FURNITURE / MOBILE MÖBEL

VIEW AND PROJECTION OF THE OBJECT / ANSICHT DES OBJEKTS	DIMENSIONS (in cm) / ABMESSUNGEN (in cm)			CATALOGUE NUMBER / PRODUKT-SYMBOL	NET PRICE in EUR / NETTOPREIS in €				REMARKS / BEMERKUNGEN
	WIDTH / BREITE	DEPTH / TIEFE	HEIGHT / HÖHE		FRONT: MELAMINE* / FRONT: MELAMIN*	FRONT: FOIL* / FRONT: FOLIE*	FRONT: LACQUERED / FRONT: LACK	FRONT: NATURAL VENEER* / FRONT: FURNIER*	
	100	50	61	10K01	682	750	806	863	
	100	50	61	10K02	777	855	920	984	
	44	80	61	10K03	569	624	673	719	
	26	60	61	10K04	192				PC tower cart / Wagen auf Rollen für Mini Tower





* horizontal pattern / *Maserung horizontal

PRICES / PREISE









SIDE CABINETS / ANSTELLSCHRÄNKE AM SCHREIBTISCH

VIEW AND PROJECTION OF THE OBJECT / ANSICHT DES OBJEKTS	DIMENSIONS (in cm) / ABMESSUNGEN (in cm)			CATALOGUE NUMBER / PRODUKT-SYMBOL	NET PRICE in EUR / NETTOPREIS in €	REMARKS / BEMERKUNGEN
	WIDTH / BREITE	DEPTH / TIEFE	HEIGHT / HÖHE			
	28	48	65	10K05	72	internal dimensions: 23x50x49H cm / Innenmaß 23x50x49Hcm
	23	2,5	55	14K36	46	metal cover to 10K05 / Metall-schutzblende

SIDE CABINETS / ANSTELLSCHRÄNKE

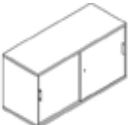

VIEW AND PROJECTION OF THE OBJECT / ANSICHT DES OBJEKTS	DIMENSIONS (in cm) / ABMESSUNGEN (in cm)			CATALOGUE NUMBER / PRODUKT-SYMBOL	NET PRICE in EUR / NETTOPREIS in €				REMARKS / BEMERKUNGEN
	WIDTH / BREITE	DEPTH / TIEFE	HEIGHT / HÖHE		FRONT: MELAMINE* / FRONT: MELAMIN*	FRONT: FOIL* / FRONT: FOLIE*	FRONT: LACQUERED / FRONT: LACK	FRONT: NATURAL VENEER* / FRONT: FURNIER*	
	44,4	80	65	10K06	576*	633*	682	730*	pedestal on feet, pencil case and 3 drawers, metal insert drawers, central lock, silent system / Container auf Stellfüßen, Stiftablage und 3 Schubladen (Metall)
	80,4	50	65	10K07	423*	457*	485	519*	jalousie cabinet, drawer in upper part, left or right hand opening / Rolladenschrank, im oberen Teil eine Schublade, Rolade links oder rechts
	120,4	50	65	10K08	496*	534*	567	526*	jalousie cabinet, drawer in upper part, left or right hand opening / Rolladenschrank, im oberen Teil eine Schublade, Rolade links oder rechts
	80,4	50	65	10K09	365*	394*	418	435*	cabinet with doors, drawer in upper part, fronts of drawer and doors the same / Schrank mit Schublade und Volltüren in gleicher Oberfläche.
	120,4	50	65	10K10	486*	524*	557	595*	cabinet with doors, drawer in upper part, fronts of drawer and doors the same / Schrank mit Schublade und Volltüren in gleicher Oberfläche.

* horizontal pattern / *Maserung horizontal

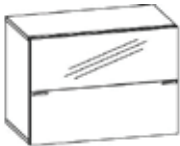

SIDE CABINETS / ANSTELLSCHRÄNKE						
VIEW AND PROJECTION OF THE OBJECT / ANSICHT DES OBJEKTS	DIMENSIONS (in cm) / ABMESSUNGEN (in cm)			CATALOGUE NUMBER / PRODUKT-SYMBOL	NET PRICE in EUR / NETTOPREIS in €	REMARKS / BEMERKUNGEN
	WIDTH / BREITE	DEPTH / TIEFE	HEIGHT / HÖHE		FRONT: MELAMINE* / FRONT: MELAMIN*	
	80,4	48	65	10K11	136	to support a desk / Ansatzregal um den Schreibtisch zu befestigen
	120,4	48	65	10K12	196	to support a desk / Ansatzregal um den Schreibtisch zu befestigen
	80,4	48	65	10K13	227	cabinet with sliding door / Schiebetürschrank
	120,4	48	65	10K14 RIGHT / RECHTS	275	cabinet with slipping door to support a desk on the side with open shelves / Schiebetürschrank um den Schreibtisch zu befestigen von der Regalseite
				10K14 LEFT / LINKS		
	120,4	48	65	10K15	297	cabinet with sliding door / Schiebetürschrank
	80,4	48	65	10K16	281	jaloussie cabinet / Rolladenschrank
	120,4	48	65	10K17 RIGHT / RECHTS	349	jaloussie cabinet with open shelves to support desk on the side / Rolladenschrank um den Schreibtisch zu befestigen von der Regalseite
				10K17 LEFT / LINKS		
	120,4	48	65	10K18	367	jaloussie cabinet / Rolladenschrank

PRICES / PREISE

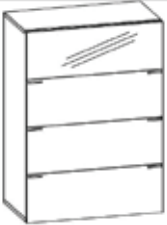
CABINETS WITH VERTICALLY OPENED DOORS / SCHRÄNKE MIT KLAPPENÖFFNUNG



VIEW AND PROJECTION OF THE OBJECT / ANSICHT DES OBJEKTS	DIMENSIONS (in cm) / ABMESSUNGEN (in cm)			CATALOGUE NUMBER / PRODUKT-SYMBOL	NET PRICE in EUR / NETTOPREIS in €				REMARKS / BEMERKUNGEN
	WIDTH / BREITE	DEPTH / TIEFE	HEIGHT / HÖHE		FRONT: MELAMINE* / FRONT: MELAMIN*	FRONT: FOIL* / FRONT: FOLIE*	FRONT: LACQUERED / FRONT: LACK	FRONT: NATURAL VENEER* / FRONT: FURNIER*	
	100,4	44	39	06K01	313*	346*	374	401*	
	100,4	44	76	06K02	780*	857*	947	973*	upper part glass / Obereteil Glas
	100,4	44	112	06K03	1034*	1137*	1249	1298*	upper part glass / Obereteil Glas
	100,4	44	149	06K04	1252*	1375*	1495	1572*	upper part glass / Obereteil Glas

CABINETS WITH DRAWERS / SCHUBLADENSCHRÄNKE

	100,4	44	18	06K05	266*	292*	313	335*	
	100,4	44	39	06K06	425*	466*	502	537*	

* horizontal pattern / *Maserung horizontal



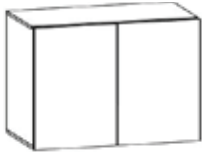
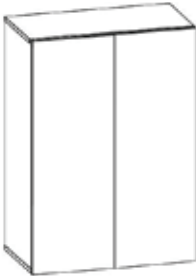
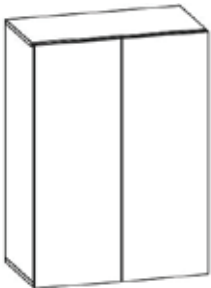



CABINETS WITH DOOR / SCHRÄNKE MIT VOLLTÜREN



VIEW AND PROJECTION OF THE OBJECT / ANSICHT DES OBJEKTS	DIMENSIONS (in cm) / ABMESSUNGEN (in cm)			CATALOGUE NUMBER / PRODUKT-SYMBOL	NET PRICE in EUR / NETTOPREIS in €				
	WIDTH / BREITE	DEPTH / TIEFE	HEIGHT / HÖHE		FRONT: MELAMINE* / FRONT: MELAMIN*	FRONT: FOIL* / FRONT: FOLIE*	FRONT: LACQUERED / FRONT: LACK	FRONT: NATURAL VENEER* / FRONT: FURNIER*	FRONT: GLASS / FRONT: GLAS
	100,4	44	39	06K07	292*	322*	347	377*	696
	100,4	44	76	06K08	416*	458*	481	529*	900
	100,4	44	112	06K09	529*	582*	607	671*	1098
	100,4	44	149	06K10	692*	761**	790	874*	1345
	100,4	44	149	06K11	735*	809**	843	927*	Wardrobe, not available with glass door / Garderobenschrank

* horizontal pattern / Maserung horizontal

** vertical pattern / Maserung vertical

PRICES / PREISE

OPEN CABINETS / REGALE						
VIEW AND PROJECTION OF THE OBJECT / ANSICHT DES OBJEKTS	DIMENSIONS (in cm) / ABMESSUNGEN (in cm)			CATALOGUE NUMBER / PRODUKT-SYMBOL	NET PRICE in EUR / NETTOPREIS in €)	REMARKS / BEMERKUNGEN
	WIDTH / BREITE	DEPTH / TIEFE	HEIGHT / HÖHE			
	100	42	18	O6K12	89	
	100		39	O6K13	129	
	100		76	O6K14	191	
	100		112	O6K15	248	
	100		149	O6K16	306	
	100		149	O6K17	351	wardrobe and file cabinet / Garderobenschrank, rechts Ablageböden

OPEN CABINETS WITH BUILT-IN DRAWERS / REGALE MIT SCHUBLADEN						
	100	42	76	O6K18	791	open cabinets with built-in drawers. Drawers' fronts – lacquered MDF / Regal mit Schubladen (Fronten der Schubladen MDF lackiert)
	100		112	O6K19	852	
	100		149	O6K20	916	

HANGING SHELF / HÄNGEREGAL

VIEW AND PROJECTION OF THE OBJECT / ANSICHT DES OBJEKTS	DIMENSIONS (in cm) / ABMESSUNGEN (in cm)			CATALOGUE NUMBER / PRODUKT-SYMBOL	NET PRICE in EUR / NETTOPREIS in €	REMARKS / BEMERKUNGEN
	WIDTH / BREITE	DEPTH / TIEFE	HEIGHT / HÖHE			
	100	25	25	06K21	265	hanging shelf, silver lacquered MDF, vertical part satinato glass / Hänge-regal, MDF Silber lackiert, vertikaler Element aus satinierten Glas

HANGING CABINETS / HÄNGESCHRÄNKE

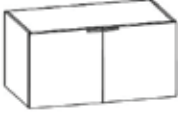



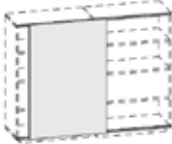
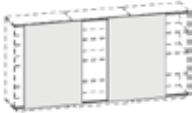

VIEW AND PROJECTION OF THE OBJECT / ANSICHT DES OBJEKTS	DIMENSIONS (in cm) / ABMESSUNGEN (in cm)			CATALOGUE NUMBER / PRODUKT-SYMBOL	NET PRICE in EUR / NETTOPREIS in €					REMARKS / BEMERKUNGEN
	WIDTH / BREITE	DEPTH / TIEFE	HEIGHT / HÖHE		FRONT: MELAMINE* / FRONT: MELAMIN*	FRONT: FOIL* / FRONT: FOLIE*	FRONT: LACQUERED / FRONT: LACK	FRONT: NATURAL VENEER* / FRONT: FURNIER*	FRONT: UPHOLSTERY / FRONT: POLSTER	
	50	44	100	06K22	326	357	381	417	547	fronts of the cabinets universal – left and right / Fronten Rechts / Links
	100	44	50	06K23	334	367	391	427	557	fronts of the cabinets universal – up and down / Fronten oben/ Unten

SLIDING DOORS FOR OPEN CABINETS / SCHIEBETÜREN FÜR REGALE

VIEW AND PROJECTION OF THE OBJECT / ANSICHT DES OBJEKTS	DIMENSIONS (in cm) / ABMESSUNGEN (in cm)			CATALOGUE NUMBER / PRODUKT-SYMBOL	NET PRICE in EUR / NETTOPREIS in €			REMARKS / BEMERKUNGEN
	WIDTH / BREITE	DEPTH / TIEFE	HEIGHT / HÖHE		FRONT: MELAMINE* / FRONT: MELAMIN*	FRONT: GLASS / FRONT: GLAS	FRONT: UPHOLSTERY / FRONT: POLSTER	
	200	-	76	14K07	713	735	1002	given width including door with the guide profile, door width is 100 cm / angegebene Breiter ist von der Tür mit der Führung. Türbreite 100cm
	200	-	112	14K08	770	800	1109	
	200	-	149	14K09	826	894	1215	
	300	-	76	14K10	1410	1375	1758	
	300	-	112	14K11	1513	1505	1972	
	300	-	149	14K12	1637	1690	2185	

PRICES / PREISE

BOTTOM RINGS AND SLATS / SOCKEL UND LEISTEN





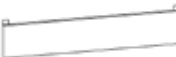

VIEW AND PROJECTION OF THE OBJECT / ANSICHT DES OBJEKTS	DIMENSIONS (in cm) / ABMESSUNGEN (in cm)			CATALOGUE NUMBER / PRODUKT-SYMBOL	NET PRICE in EUR / NETTOPREIS in €	REMARKS / BEMERKUNGEN
	WIDTH / BREITE	DEPTH / TIEFE	HEIGHT / HÖHE			
	88	42	5	14K01	56	metal bottom ring, powder painted / Metallsockel, pulverbeschichtet
	88	-	6	14K02	76	bottom slat, Polished aluminium. Two chrome feet included / Sockelleiste, poliertes Aluminium
	188	-		14K03	158	
	288	-		14K04	236	
	138	38	19	14K05	401	chrome cabinet base for cabinets 1 OH and 2 OH only / Verchromte Kufe
	238	38	19	14K06	447	

SCREENS / TRENNWÄNDE FÜR SCHREIBTISCHE

VIEW AND PROJECTION OF THE OBJECT / ANSICHT DES OBJEKTS	DIMENSIONS (in cm) / ABMESSUNGEN (in cm)			CATALOGUE NUMBER / PRODUKT-SYMBOL	NET PRICE in EUR / NETTOPREIS in €	REMARKS / BEMERKUNGEN
	WIDTH / BREITE	DEPTH / TIEFE	HEIGHT / HÖHE			
	200	44	44	14K17	318	screen, two sides upholstered, with functional slat / Trennwand mit Funktionsleiste zweiseitig gepolstert
	180			14K18	290	
	160			14K19	262	
	140			14K20	232	
	120			14K21	203	

MODESTY PANNELS / BLENDEN

VIEW AND PROJECTION OF THE OBJECT / ANSICHT DES OBJEKTS	DIMENSIONS (in cm) / ABMESSUNGEN (in cm)			CATALOGUE NUMBER / PRODUKT-SYMBOL	NET PRICE in EUR / NETTOPREIS in €		REMARKS / BEMERKUNGEN
	WIDTH / BREITE	DEPTH / TIEFE	HEIGHT / HÖHE		MELAMINE / MELAMIN	FOIL / FOLIE	
	183	-	30	14K22	53	126	for desk 200 cm wide / für Tische von 200 cm-Breite
	163			14K23	49	113	for desk 180 cm wide / für Tische von 180cm-Breite
	143			14K24	46	103	for desk 160 cm wide / für Tische von 160 cm-Breite
	123			14K25	43	90	for desk 140 cm wide / für Tische von 140 cm-Breite
	103			14K26	39	81	for desk 120 cm wide / für Tische von 120 cm-Breite

ACCESSORIES / ZUBEHÖR						
VIEW AND PROJECTION OF THE OBJECT / ANSICHT DES OBJEKTS	DIMENSIONS (in cm) / ABMESSUNGEN (in cm)			CATALOGUE NUMBER / PRODUKT-SYMBOL	NET PRICE in EUR / NETTOPREIS in €)	REMARKS / BEMERKUNGEN
	WIDTH / BREITE	DEPTH / TIEFE	HEIGHT / HÖHE			
	50	26	52	14K13	67	PC tower shelf, metal powder painted / Ablage für den Computer, Metall pulverbeschichtet
	50	26	52	14K14	91	printer and paper shelf, metal powder painted / Ablage für den Drucker und Papier. Elemente zu 14K14, fest eingestellt ohne Regulierung. Abstand zwischen den Regalbrettern 15,5cm. Metall pulverbeschichtet
	9	2	50	14K15	32	cable shield, metal powder painted / Kabelverblendung, Metall pulverbeschichtet
	35	6	8	14K16	44	socket outlet, 5 sockets, switch, control light, cable, european standard / Verstärkungsleiste, 5 Steckdosenanschlüsse, Schalter und Kabel
	18	16	16	14K27	78	LCD screen holder, fixed to the functional slat at the partition wall, horizontal and Vertical regulation / Monitorgriff für LCD, an der Funktionsleiste befestigt, vertikale und horizontale Regulierung
	100	22	15	14K28	688	pencil case with socket outlet, 3 sockets, 1x RJ45, 1x RJ 11, assembled in desks O2K01-04, cover in the leather PRESCOTT from NOTI / Stiftablage mit Verstärkungsleiste, 3x Steckdosen, 1x RJ45, 1x RJ 12, Abdeckung im Leder PRESCOTT aus NOTI
	150	22	4	14K29	575	lightning unit, assembled in conference tables O3K02 and O3K03, cable included / Beleuchtetes Modul, zum Konferenztisch O3K02 und O3K03. Mit Verstärkungskabel

