



Executive furniture  
Chefzimmerprogramm

# Meritum

Executive set of office furniture  
Chefzimmerprogramm

design: Piotr Kuchciński

The MERITUM combines discreet smartness with classical form what gives full satisfaction to group of manager type people who admire prestige and individuality. The MERITUM set includes elements, which enable freedom in creating functional managerial working station, which ensure comfort during long hours.

Das Chefzimmer MERITUM birgt in sich eine diskrete Eleganz in klassischer Form, ermöglicht auf ganzer Linie Zufriedenheit für Personen, die Prestige und Individualität schätzen. Diese Kollektion besteht aus Teilen, die es erlauben, eine grosse Ungezwungenheit unter Schaffung eines funktionellen Chefzimmers zu ermöglichen und sogar einen gewissen Komfort entstehen zu lassen, wenn es sich um vielstündliche Arbeit handelt.

## COLLECTION ELEMENTS / ELEMENTE DER KOLLEKTION

### DESKS, TABLES, EXTENTION DESKS / SCHREIBTISCHE, TISCHE, ANSTATTZTISCHE

DESKTOP / TISCHPLATTE	top desk - foiled 38mm MDF board / Tischplatte – MDF 38 mm Folie
	bottom desk – 12 mm varnished MDF board / Untere Platte – MDF 12 mm lackiert
FRAME / GESTELL	site frames 44mm milled varnished MDF plates / Füße, MDF Platte 44 mm, gefräst, lackiert
	legs connection construction – 18mm varnished MDF board, in M5 is used 29mm MDF board / Verbindungskonstruktion MDF 18 mm, lackiert (bei M5 MDF 29 mm)

### PEDESTALS / CONTAINER

DRAWERS / SCHUBLADEN	Version 1 pencil case, three drawers / Materialauszug, 3 Schubladen	Version 2 pencil case, 1 drawer, file frame / Materialauszug, 2 Schubladen, Hängerregistratur
	FRONT: foiled MDF 18mm / FRONTEN: MDF 18mm, Foile	
	metal insert drawers / Schubladeneinsätze, Metall, pulverbeschichtet	
	blockade preventing from pulling out more than one drawer / Ausziehsperre	
	central lock / Zentralschloßverschluss	
BODY / KORPUS	18 mm melamine chipboard finished with PVC edge band / Melaminplatte, 18 mm, PVC-Kanten	
TOP RING / ABDECKPLATTE	top of pedestal - milled and foiled 38 mm MDF board, 12 mm varnished MDF board / Korpus: MDF 38 mm, gefräst, Folie + MDF 12 mm lackiert	

### CABINETS / SCHRÄNKE

TYPES / PRODUKT	file cabinet, with glass door, wardrobe, open shelves / Schrank für Kühlschrank, Schrank mit Glastür, Aktenschrank, Garderobenschrank	
BODY / KORPUS	18 mm melamine chipboard / Melaminplatte 18 mm	
FRONT / FRONTEN	Version 1 MDF 18mm, foiled / MDF 18mm Folie	Version 2 glass door: 5mm tempered glass / Glastür: Hartglas 5 mm
ADDITIONAL INFORMATION / ZUSÄTZLICHE INFORMATIONEN	level adjustment / Bodenausgleich	
	secura shelf support / Einlegeböden	
	128 width metal satin handles / Satin Griffe 128 mm	
	soft closing slat / Leiste soft close	only for cabinets with plate doors / bei Aktenschränken ohne Glasfronten
	3 point lock / Drehverschluss	in cabinets with plate doors of height 30H and higher / Bei Aktenschränken 30H
NOTE! / WICHTIG!	TOP RINGS FOR THE CABINETS SHOULD BE ORDERED SEPARATELY / ABDECKPLATTE FÜR SCHRÄNKE SEPARAT BESTELLEN!	

### TOP CABINETS RINGS / ABDECKPLATTE BEI DEN SCHRÄNKEN

TOP RING / ABDECKPLATTE	top desk – foiled 38 mm MDF board / Platte - MDF 38 mm Folie
	bottom desk – 12 mm varnished MDF board / Untere Platte - MDF 12 mm lackiert

## FINISHING / AUSFÜHRUNG

### DESKS TABLES EXTENTION DESKS /SCHREIBTISCHE TISCHE ANSÄTZE

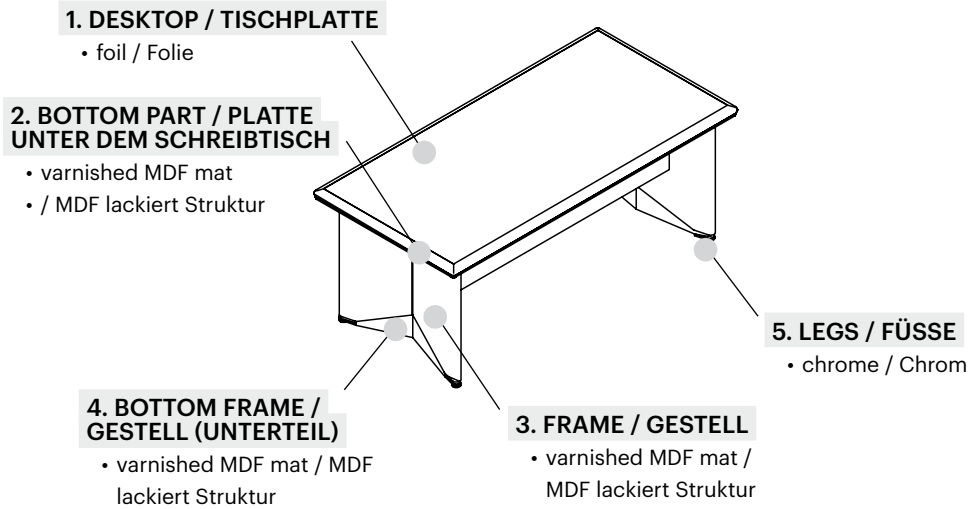

### PEDESTALS / CONTAINER

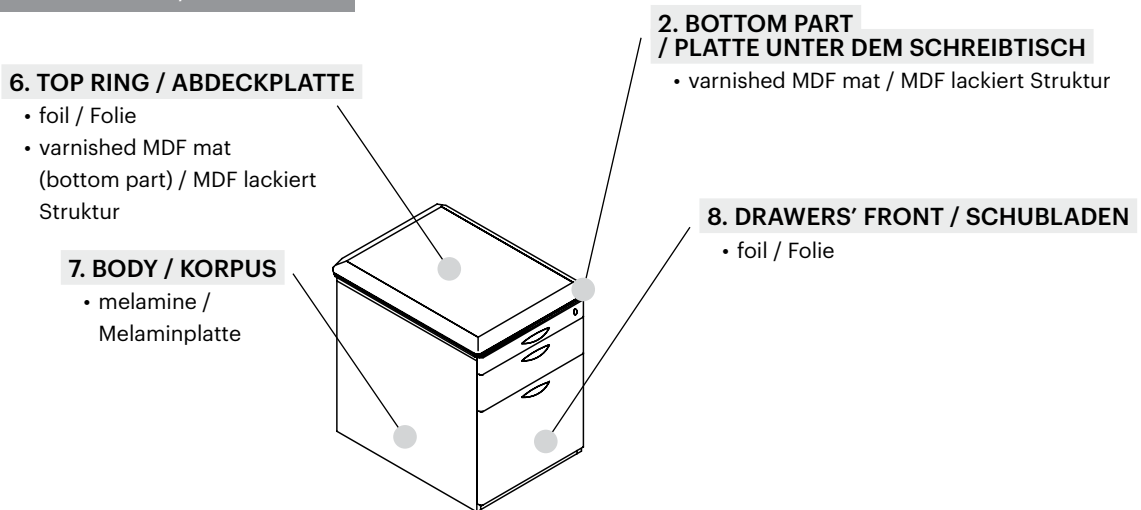



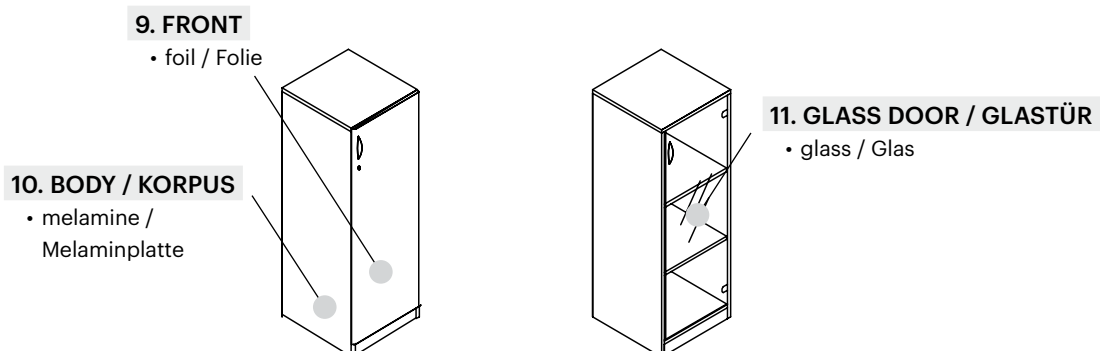







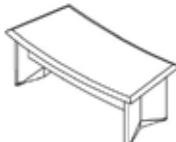

### CABINETS / SCHRÄNKE

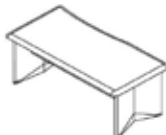

DESKS, TABLES, EXTENTION DESKS / SCHREIBTISCHE, TISCHE, ANSÄTZTISCHE	PEDESTALS / CONTAINER	CABINETS / SCHRÄNKE
<p><b>1. TOP / TISCHPLATTE</b></p> <hr/> <p>foil / Folie</p> <ul style="list-style-type: none"> <li>- oak / Eiche 3600</li> <li>- light walnut / helle Nuss 3200</li> <li>- dark walnut / dunkle Nuss 3100</li> </ul> <p><b>2. 3. BOTTOM PART AND FRAME / PLATTE UNTER DEM SCHREIBTISCH UND GESTELL</b></p> <hr/> <p>varnished MDF mat / MDF lackiert Struktur</p> <ul style="list-style-type: none"> <li>- dark graphite / Intensives Graphit W</li> <li>- true grey / Echtes Grau Z</li> <li>- white / Weiß R</li> <li>- sand / Sand TS</li> </ul> <p><b>4. BOTTOM FRAME / GESTELL</b></p> <hr/> <p>varnished MDF mat / MDF lackiert Struktur</p> <ul style="list-style-type: none"> <li>- deep grey / Tiefes Grau U</li> <li>- true grey / echtes Grau Z</li> <li>- white / Weiß R</li> <li>- sand / Sand TS</li> </ul>	<p><b>8. FRONT / FRONTEN</b></p> <hr/> <p>foil / Folie</p> <ul style="list-style-type: none"> <li>- oak / Eiche 3600</li> <li>- light walnut / helle Nuss 3200</li> <li>- dark walnut / dunkle Nuss 3100</li> </ul> <p><b>7. BODY / KORPUS</b></p> <hr/> <p>melamine board / Melamin</p> <ul style="list-style-type: none"> <li>- graphite / Graphit 0300</li> <li>- white / Weiß 2700</li> <li>- true grey / Echtes Grau 1208</li> <li>- sand / Sand 2850</li> </ul> <p><b>6. TOP RING / ABDECKPLATTE</b></p> <hr/> <p>foil / Folie</p> <ul style="list-style-type: none"> <li>- oak / Eiche 3600</li> <li>- light walnut / helle Nuss 3200</li> <li>- dark walnut / dunkle Nuss 3100</li> </ul>	<p><b>9. FRONT / FRONTEN</b></p> <hr/> <p>foil / Folie</p> <ul style="list-style-type: none"> <li>- oak / Eiche 3600</li> <li>- light walnut / helle Nuss 3200</li> <li>- dark walnut / dunkle Nuss 3100</li> </ul> <p><b>11. GLASS DOOR / GLASTÜR</b></p> <hr/> <p>glass / Glas</p> <ul style="list-style-type: none"> <li>- clear / klar</li> </ul> <p><b>10. BODY / KORPUS</b></p> <hr/> <p>melamine board / Melamin</p> <ul style="list-style-type: none"> <li>- graphite / Graphit 0300</li> <li>- white / Weiß 2700</li> <li>- true grey / Echtes Grau 1208</li> <li>- sand / Sand 2850</li> </ul>

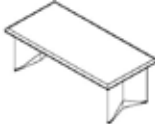
## PRICES / PREISE

DESKS / SCHREIBTISCHE						
VIEW AND PROJECTION OF THE OBJECT / ANSICHT DES OBJEKTS	DIMENSIONS (in cm) / ABMESSUNGEN (in cm)			CATALOGUE NUMBER / PRODUKT- SYMBOL	NET PRICE in EUR / NETTOPREIS in €	REMARKS / BEMERKUNGEN
	WIDTH / BREITE	DEPTH / TIEFE	HEIGHT / HÖHE			
	200	100	74	M01	1241	
	180	90		M02	1097	
 left / links  right / rechts 	220	110	74	M03	1431	
				M04		
 	200	90	74	M05	1308	
 right / rechts  left / links 	180	90	74	M06	1154	
				M07		
CONFERENCE TABLES / KONFERENZTISCHE						
	234	120	74	M08	1740	
	200	100	74	M46	1241	
	180	90	74	M47	1097	
MODULAR CONFERENCE TABLE / KONFERENZTISCHE						
	120	120	74	M09	857	end-module of a conference table. Used for creating a modular conference table. For joining M9 and M10, two elements M11 are necessary. / Endelement, um M9 und M10 zu verbinden bitte 2xM11 verwenden
	140	120	74	M10	886	middle-module of a conference table. Used for creating a modular conference table. For joining M9 and M10, two elements M11 are necessary. / Mitelement um 2xM10 zu verbinden bitte M12 verwenden

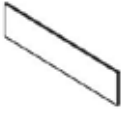

## CONNECTORS OF CONFERENCE TABLES / VERBINDUNGSELEMENTE ZUM KONFERENZTISCH

VIEW AND PROJECTION OF THE OBJECT / ANSICHT DES OBJEKTS	DIMENSIONS (in cm) / ABMESSUNGEN (in cm)			CATALOGUE NUMBER / PRODUKT-SYMBOL	NET PRICE in EUR / NETTOPREIS in €	REMARKS / BEMERKUNGEN
	WIDTH / BREITE	DEPTH / TIEFE	HEIGHT / HÖHE			
	147	2,5	32	M11	92	for joining M9 and M10, two pieces are necessary / um M9 und M10 zur verbinden bitte 2xM11 verwenden
	136			M12	87	for joining two elements M10, two pieces are necessary / um 2xM10 zur verbinden bitte 2xM12 verwenden





## ELECTRICAL POWER ADAPTER / BEFESTIGUNGSSÄULE

	11	34	M19	547	cable kolumn with Power supply facility: 3 sockets 230V, 2 net sockets (RJ 45) / VerstärkungsLeiste: 3 Steckdosen 230V, 2 Netzanschlüsse (RJ 45)
--	----	----	-----	-----	--

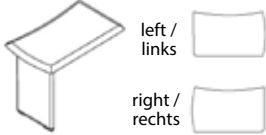

## TABLES / TISCHE



	120	120	74	M13	1062
	79	79	60	M18	527



## PC EXTENSION DESKS / ANSATZTISCH





 left / links  right / rechts 	98	60	74	M14	360	perpendicular extension desk / Ansatzstisch senkrecht
				M15		
	109	100	74	M16	785	lengthwise / Ansatzstisch entlang
	107	90		M17	710	

## PRICES / PREISE

PEDESTALS / CONTAINER						
VIEW AND PROJECTION OF THE OBJECT / ANSICHT DES OBJEKTS	DIMENSIONS (in cm) / ABMESSUNGEN (in cm)			CATALOGUE NUMBER / PRODUKT- SYMBOL	NET PRICE in EUR / NETTOPREIS in €	REMARKS / BEMERKUNGEN
	WIDTH / BREITE	DEPTH / TIEFE	HEIGHT / HÖHE			
	45	60	61	M20	591	pedestal with pencil case, three metal drawers / Container mit Zentralverschluss, Materialauszug, Schubladen (Metall)
				M21	591	pedestal with pencil case, metal drawer and bottom drawer for hanging files / Container mit Zentralverschluss, Materialauszug, Schublade, Hängeregistratur
				M22	251	pedestal with door open on right side / Container, Tür Rechts

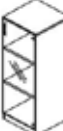

CABINETS / SCHRÄNKE						
	40	41	78	M23	246	cabinet with temper glass door / Schrank mit Glastür, Hartglas
	40	42	78	M24	208	file cabinet with three point lock / Aktenschrank, Verschluss
	49	48	83	M25	1744	cabinet with mini fridge in top cabinet ring ventilator / Kühl-schrank minibar



CABINETS 2OH / SCHRÄNKE 2OH						
VIEW AND PROJECTION OF THE OBJECT / ANSICHT DES OBJEKTS	DIMENSIONS (in cm) / ABMESSUNGEN (in cm)			CATALOGUE NUMBER / PRODUKT-SYMBOL	NET PRICE in EUR / NETTOPREIS in €	REMARKS / BEMERKUNGEN
	WIDTH / BREITE	DEPTH / TIEFE	HEIGHT / HÖHE			
	80	40	78	M26	155	open file cabinet / Regal
	80	41	78	M27	419	cabinet with temper glass door / Schrank mit Glastür, Hartglas
	80	42	78	M28	323	file cabinet with three point lock / Aktenschrank, Verschluss

CABINETS 3OH / SCHRÄNKE 3OH						
	40	42	114	M29	294	file cabinet with three point lock / Aktenschrank, Verschluss
	40	41	114	M30	313	cabinet with temper glass door / Schrank mit Glastür, Hartglas
	80	40	114	M31	206	open file cabinet / Regal
	80	41	114	M32	520	cabinet with temper glass door / Schrank mit Glastür, Hartglas
	80	42	114	M33	440	file cabinet with three point lock / Aktenschrank, Verschluss

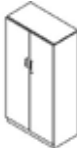

## PRICES / PREISE

CABINETS 3OH / SCHRÄNKE 3OH						
VIEW AND PROJECTION OF THE OBJECT / ANSICHT DES OBJEKTS	DIMENSIONS (in cm) / ABMESSUNGEN (in cm)			CATALOGUE NUMBER / PRODUKT- SYMBOL	NET PRICE in EUR / NETTOPREIS in €	REMARKS / BEMERKUNGEN
	WIDTH / BREITE	DEPTH / TIEFE	HEIGHT / HÖHE			
	40	42	150	M34	437	cabinet with tempe- red glass door, three point lock / Schrank mit Glastüren (Hart- glas) Verschluss
	40	42	150	M35	379	file cabinet with three point lock / Akten- schrank, Verschluss
	80	40	150	M36	251	open file cabinet / Regal

CABINETS 4OH / SCHRÄNKE 4OH						
	80	42	150	M37	684	file cabinet with three point lock and tempered glass door / Schrank mit Glastür, Hartglas, Verschluss
				M38	545	file cabinet with three point lock / Akten- schrank, Verschluss
				M39	553	file wardrobe cabinet with three point lock / Garderobenschrank, Verschluss

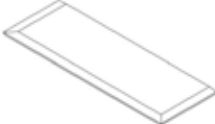
TOP CABINET RING / ABDECKPLATTE						
VIEW AND PROJECTION OF THE OBJECT / ANSICHT DES OBJEKTS	DIMENSIONS (in cm) / ABMESSUNGEN (in cm)			CATALOGUE NUMBER / PRODUKT- SYMBOL	NET PRICE in EUR / NETTOPREIS in €	REMARKS / BEMERKUNGEN
	WIDTH / BREITE	DEPTH / TIEFE	HEIGHT / HÖHE			
	42	43	5	M40	71	for assembling in cabinets of the width 40cm / Zum 40cm Schrankbreite
	82			M41	102	for assembling in cabinets of the width 80cm / Zum 80cm Schrankbreite
	122			M42	152	for assembling In cabinets of the same height, put together to the widt 120cm / Zum 120cm Schrankbreite
	162			M43	200	for assembling In cabinets of the same height, put together to the widt 160cm / Zum 160cm Schrankbreite
	202			M44	249	for assembling In cabinets of the same height, put together to the widt 200cm / Zum 200cm Schrankbreite
	242			M45	298	for assembling In cabinets of the same height, put together to the widt 240cm / Zum 240cm Schrankbreite