



PEDESTALS CONTAINER

The K2 pedestals complement the choice of our furniture and are compatible with the office furniture ranges and reception counters. Their main feature is the possibility to select items according to the Client's preferences.

The pedestals have specially designed pull on the side instead of handles. For the Clients who like traditional solutions we can mount handles, as well.

The collection includes free-standing pedestals and underdesk pedestals, 60 and 80 cm deep, adapted to desks of different depths. The underdesk pedestals can be fitted with high wheels, hidden in a bottom panel or with a footer. Free-standing pedestals are fitted with feet with level adjustment.

Our new offer includes slim line pedestals - with a width of 33 cm, making it ideally suited for smaller offices, where space saving is the key issue.

The Client can choose drawers fitted with metal or plastic inserts. As standard, all drawers are equipped with self-closing system improving comfort, central locking and an additional drawer with a pencil case (in most containers). An additional option is a soft closing increasing the comfort of work in an office.

Accessories such as dividers or a special organizer for drawers allow to customize to the Client's preferences and increase the functionality of the workplace.

A pillow with non-slip underside enhances functionality of the pedestal.

Various directions of the grain on the drawers' fronts and topings (in free-standing pedestals) allow a perfect fitting to the office equipment, enhancing the aesthetics of the workplace.

Das Container-System ist eine Neuheit, die unser Angebot ergänzt und mit Büromöbel und Empfangstheken kompatibel ist. Sein Hauptmerkmal ist die Möglichkeit, Ausrüstungsteile nach Bedarf auszuwählen.

Die Container sind grifflos und die Schubladen werden mit einer speziellen Handleiste an der Seite geöffnet. Für Menschen, die traditionelle Lösungen mögen, können Griffe montiert werden. Das System besteht aus Containern, die an oder unter Schreibtischen platziert werden können und 60 cm und 80 cm tief sind, so dass sie zu Schreibtischen mit verschiedenen Tiefen passen. Die Container können mit hohen oder eingelassenen Rollen sowie Fußkappen ausgerüstet werden.

Die Container, die an den Schreibtischen platziert werden, werden mit höhenverstellbaren Fußkappen ausgestattet.

Eine Neuheit sind schmale Container mit einer Breite von 33 cm. Dadurch sind sie ideal für kleine Büros, wo Platzersparnis im Vordergrund steht.

Schubladen können mit Schubeinsätzen aus Metall oder Kunststoff je nach Bedarf ausgestattet werden. Standardmäßig sind alle Schubladen mit einem Selbsteinzug, welcher den Komfort verbessert, und der Zentralverriegelung sowie einem zusätzlichen Utensilienfach ausgestattet. Eine zusätzliche Option stellt ein Dämpfersystem dar, das den Komfort der Arbeit im Büro erhöht. Durch weiteres Accessories wie Trennleisten für Unterlagen oder Schubladeneinsätze kann der Container nach eigenen Wünschen angepasst und die Funktionalität des Arbeitsplatzes erhöht werden.

Die Ausstattung des Containers mit einer rutschfesten Matte verbessert seine Funktionalität.

Die Möglichkeit, die Richtung der Maserung an den Fronten der Schubladen und oberen Rändern (bei Container, die an den Schreibtischen platziert werden) auszuwählen, sorgt für die perfekte Anpassung an die sonstige Büroausstattung und leistet einen positiven Beitrag zur Ästhetik des Arbeitsplatzes.



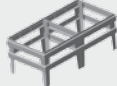
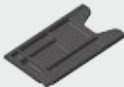
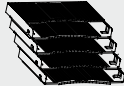

PEDESTALS – COMMON FEATURES / CONTAINER – ALLGEMEINE INFORMATIONEN

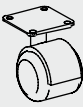

BODY / KORPUS	18 mm melamine faced chipboard, PCV edges / Holzspanplatte mit Melaminoberfläche, Stärke 18 mm, mit PVC-Kantenband	
DRAWERS / SCHUBLADEN	no-handle pedestals: there is a space between the body and drawer fronts in the function of the handle, finished with the aluminum slot. / Container sind grifflos: zwischen dem Korpus und den Schubladenfronten ist eine Leerspalt vorhanden, die als eine Art Ziehgriff dient, verkleidet mit Aluleiste.	
	finishing of the slot: / Verkleidung der Ziehleiste:	
	version1 standard, anodized aluminum / Standard, eloxiertes Aluminium	version2 / Variant 2 for additional payment, anodized aluminum, powder-painted, colors according to the BALMA pattern, additional payment of 25 EUR for the pedestal / Gegen Aufpreis, eloxiertes Aluminium, pulverlackiert, Farbton gem. BALMA-Farbtonkarte, Aufpreis für den Container
	drawers inserts: / Schubladeneinsätze:	
	Version1 plastic, black / Kunststoff, Schwarz	Version2 metal, black / Metall, Schwarz
	drawer extension of 3/4, bearing capacity of 25 kg / 3/4-Auszug der Schublade, Belastung 25 kg	
file drawer extension (refers to both variants): full, bearing capacity: 40kg in case of 60 cm deep pedestals, 50 kg in case of 80 cm deep pedestals / Auszug des Hängeregisters (gilt für beide Ausführungen): voll Belastung: 40kg bei Containern mit einer Tiefe von 60 cm, 50kg bei Containern mit einer Tiefe von 80 cm		
FILE DRAWER / HÄNGEREGISTERAUSZUG	plastic insert, black / Kunststoffeinsatz, Schwarz	
	60cm deep pedestals / Container mit einer Tiefe von 60cm 	80cm deep pedestals / Container mit einer Tiefe von 80cm 
CLOSING / SCHLIESSUNG	central locking system, 2 one-element keys / Zentralschloss, 2 einfache Schlüssel	
	blockade preventing from pulling out more than one drawer / Ausziehsperre	
	the above mentioned does not refer to the pencil drawer / Es gilt nicht für Materialauszug	
	lock on the right, in the pencil drawer / Schloss rechts, im Utensilienfach	
	Version1 standard: selfclose	Version2 for additional payment / gegen Aufpreis softclose 29 EUR per pedestal / Softclose 29 EUR pro Container
HANDLES / GRIFFE	Version1 standard: no handles / ohne Griffe	
	Version2 for additional payment / gegen Aufpreis to chose from handles on page 266 / Griffe nach Auswahl nach der Preisliste der Griffe (Seite 266)	
PENCIL DRAWER / MATERIALAUSZUG	the pencil drawer is not connected with the blockade of the rest of drawers / Utensilienfach unabhängig, mit anderen Schubladen, mit Auszugssperre, nicht verbunden the pencilcase insert is made of plastic / Utensilienfach aus Kunststoff black / Schwarz 	
GRAIN LAYOUT / FRONTEN ZURÜCKZIEHEN	vertical or horizontal, body grain as on the drawing on page 256 / Frontmaserung: vertical oder horizontal nach Auswahl, Korpusmaserung siehe Seite 256	
OPTIONS / OPTIONEN		
ANTITILT	metal plate assembled in the back, recommended for pedestals with filedrawer, cost 25 EUR / Blech montiert innen im Container zur Rückwand, empfohlen für die Container mit Kartothekenrahmen, gegen Aufpreis von 25 EUR	
DRAWERS' EQUIPMENT / SCHUBLADEN	divider, p. 265 / Trennstange, Seite 265	
	document organizer / Dokumenteneinsatz to be composed from separate elements / reihenfähig plastic, black, p. 265 / Seite 265	

PEDESTALS / CONTAINER

COLLECTION ELEMENTS / ELEMENTE DER KOLLEKTION

UNDER-DESK PEDESTALS / UNTERTISCHCONTAINER			
WHEELS / ROLLEN	the option of wheels or feet: / Rollen- und Fußausführung erhältlich:		
	Version1 standard screwfitted wheels, fi40 / Ausführung 1 Standard Anschraubrollen, fi40 	Version2 the option for additional payment – recessed wheels for additional payment of 20 EUR net per the pedestal / gegen Aufpreis eingelassene Rollen Aufpreis: 20 EUR netto je Container 	Version3 with no additional payment – feet level adjustment within 10mm / im Standardpreis erhältlich, höhenverstellbare Füße im Bereich von 10mm 
TOTAL HEIGHT OF THE PEDESTAL / GESAMTHÖHE DES CONTAINERS	62,3 cm	57,5 cm	57,4 cm with regard to feet maximally screwed in / Bei max. eingeschraubten Füßen
	REMARK: dimensions stated in price tables do not include wheels and feet / WICHTIG! Abmessungen in Preistabellen ohne Rollen und Füße		
REMARK / WICHTIG!	K2-04 pedestals with a file drawer are available only in variant 1 with screw-fitted wheels / Container vom Typ K2-04 mit Hängeregister sind nur in der Ausführung 1 mit Anschraubrollen erhältlich		
LOADING / BELADUNG	admissible total loading of the pedestal: 130kg / zul. Gesamtbelastung des Containers: 130kg		
FINISHING / AUSFÜHRUNG	the color of the body and the color of the front are selected separately in the order of the pedestal / Bei der Bestellung eines Containers ist separat der Farbton des Korpus und der Front zu wählen		
	the direction of the wood grain as shown in figure on page 5 / Richtung der Maserung ist der Abbildung auf der Seite Nr. 5 zu entnehmen.		
UPPER PANEL / ABDECKBODEN	18 mm melamine faced chipboard / Holzspanplatte mit Melaminoberfläche, Stärke 18 mm		
CUSHION / SITZKISSEN	upholstered cushion, non slip material on the bottom, black filling: cushion foam is not fixed to the pedestal's panel / Unterseite aus rutschfestem Material Schwarz, Füllung: Schaum. Das Sitzkissen wird nicht am Abdeckboden des Containers befestigt		
	finishing / Bezug		
	Version1 A-group fabric according to BALMA REMARK: minimal order refers to the multiple of 2 items of the same material and color / Ausführung 1: Gewebe Gr. A gem. der Musterkarte BALMA WICHTIG! Mindestbestellmenge ist das Vielfache von 2 Stck. aus demselben Material und in demselben Farbton	Version2 the fabric of AGAVA according to the BALMA pattern, the option to order 1 item / Gewebe AGAVA gem. der Musterkarte BALMA, Bestellung je 1 Stck. möglich	

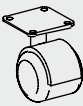
K2-07 AND K2-08 UNDER-DESK PEDESTALS (WITH NO PENCIL DRAWER) / UNTERTISCHCONTAINER K2-07 UND K2-08 (OHNE MATERIALAUSZUG)

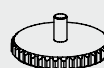
DRAWERS / SCHUBLADEN	3 drawers available only in the plastic version, black / 3 gleiche Schubladen erhältlich nur in der Kunststoffausführung, Schwarz	1 drawer, 1 file drawer plastic inserts, black / 1 Schublade, 1 Hängeregister Kunststoffeinsätze, Schwarz	
PENCIL CASE INSERT / MATERIALAUSZUG	Version1 no pencil-compartment insert / ohne Materialauszug	Version2 the option for additional payment, pencil case insert for the additional payment of 12 EUR net / gegen Aufpreis, Materialaufsatz Aufschlag: 12 EUR netto	
REMARK / WICHTIG!	limited color options / Beschränkte Farbtonauswahl		
WHEELS / ROLLEN	the option of wheels or feet: / Rollen- und Fußausführung erhältlich:		
	Version1 standard screwfitted wheels, fi40 / Standard Anschraubrollen, ø40 	Version2 the option for additional payment – sunk wheels, additional payment of: 20 EUR for the pedestal / gegen Aufpreis eingelassene Rollen Aufpreis: 20 EUR netto je Container 	Version3 the foot with no additional payment / im Standardpreis erhältlich, Fußausführung 

COLLECTION ELEMENTS / ELEMENTE DER KOLLEKTION

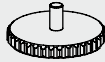
SIDE PEDESTALS / ANBAUCONTAINER	
UPPER PANEL / ABDECKBODEN	25 mm melamine faced chipboard / Holzspanplatte mit Melaminoberfläche, Stärke 25mm GRAIN LAYOUT / FRONTEN ZURÜCKZIEHEN: as on p. 5
FINISHING / AUSFÜHRUNG	the color of the body, front and top ring are selected separately in the order of the pedestal / Bei der Bestellung eines Containers ist separat der Farbton des Korpus, Font und Abdeckplatte zu wählen
HEIGHT / HÖHE	pedestals are available in 2 height variants 72cm (p.8) and 74cm (p.9) / Anbaucontainer sind in zwei Höhen erhältlich 72cm (S. 8) und 74cm (S. 9)
FEET / FÜSSE	feet level adjustment within 10mm / höhenverstellbare Füße im Bereich von 10mm  the table presents the total height of the pedestal, together with the adjustable feet with maximally screwed in feet / In der Tabelle ist die Gesamthöhe, einschließlich höhenverstellbarer Füße in voll eingeschraubter Stellung, angegeben

NARROW UNDER-DESK PEDESTALS / ANBAUCONTAINER SCHMALL	
DRAWERS / SCHUBLADEN	metal inserts / Schubladeneinsätze aus Kunststoff pencil case drawer / Materialauszug file pedestal: wire frame for files, black / Container mit Hängeregisterauszug: Hängemappenrahmen aus Draht, Schwarz

K2-32 AND K2-33 PEDESTALS / CONTAINER K2-32 UND K2-33	
FINISHING / AUSFÜHRUNG	18 mm melamine faced chipboard, veneered with a PCV veneer / Holzspanplatte mit Melaminoberfläche, Stärke 18mm, mit PVC-Kantenband
DRAWERS / SCHUBLADEN	18 mm melamine faced chipboard drawers, veneered with a PCV veneer, mounted on roller-bed rails / Schublade aus Holzspanplatte mit Melaminoberfläche, Stärke 18mm, mit PVC-Kantenband, mit gelagerten Rollführungen
WHEELS / ROLLEN	plastic wheels / Kunststoff-Laufrollen
LOCK / SCHLOSS	central locking system, 2 one-element keys / Zentralschloss, 2 einfache Schlüssel

PEDESTALS / CONTAINER

COLLECTION ELEMENTS / ELEMENTE DER KOLLEKTION

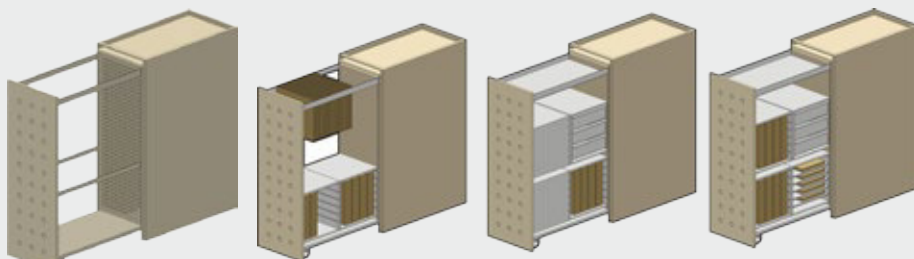
CARGO			
FRONT	version 1 / Variant 1 melamine / melaminbeschichtet	version 2 / Variant 2 natural veneer / Naturfurnier	version 3 / Variant 3 MDF with milled dimples of approx. 30 mm diameter, depth 3 mm, varnished - laquer mat / MDF gefräst - Einfresungen Durchmesser ca. 30 mm, Tiefe 3 mm abgeschrägt, Lackbeschichtung strukturiert
CARGO	<p>the basic CARGO is equipped with two hanging files' frames. It can be upgraded with shelf, box for files, or with shelves or drawers. / zwei Hängeregisterrahmen im Standard, kann mit Boden, Ordnerkasten, mit Boden oder Schubladen zusätzlich ausgestattet werden</p> 		

DESCRIPTIONS OD PARTICULAR TYPES OF ACCESSORIES / BESCHREIBUNGEN DER EINZELNENEN ACCESSORIESARTEN				
CARGO EQUIPMENT / APOTHEKEN- SCHRANK-AUSSTA- TUNG	the inside a CARGO can be configured individually, depending on the needs, guides may function as file frames, they may be equipped gaining additional functions, options: / Der Raum von Apothekerschrank ist frei konfigurierbar, je nach Bedarf. Die Führungen können als Mappenrahmen dienen. Es steht ein umfangreiches Accessoriesprogramm zur Verfügung, das neue Funktionen verleiht:			
	tray to be fixed on an upper guide / Tablett zum Aufsetzen auf der oberen Führung	box with guides / Führungskasten	shelf for boxes / Kastenbrett	box drawer / Kastenschub- blade
	made of steel sheet plate of 1,5 mm thickness, powder painted / Stahblech, Stärke 1,5 mm. pulverbeschichtet	made of varnished MDF, structure varnish, all elements made of MDF are 12 mm thick / MDF mit Lackbeschichtung, strukturiert, sämtliche Elemente aus MDF Stärke 12 mm	made of powder-painted steel sheet plate of 1.5 mm thick, to buy individually, in one box there maximum 5 shelves can be mounted / Blech, pulverbeschichtet, Stärke 1,5 mm, einzeln erhältlich. Es können in einem Kasten bis zu 5 Brettern eingesetzt werden	made of sheet plate of 1.5 mm thick, powder-painted, it is possible to mount 3 drawers in one box / Blech, pulverbeschichtet, Stärke 1,5 mm. Es können in einem Kasten bis zu 3 Schubladen eingesetzt werden

COLLECTION ELEMENTS / ELEMENTE DER KOLLEKTION

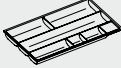
PEDESTALS WITH RAILING / CONTAINER MIT RAILING			
DRAWERS / SCHUBLADEN	metal drawer inserts with a blockade preventing from pulling out more than one drawer, with full extraction and soft closing, optional central lock, 2 jack keys / Schubladeneinsätze aus Metall, Auszugssperre, Vollauszug mit Silentschließmechanismus, Zentralschloss optional, 2 Knickschlüssel		
PENCIL CASE INSERT / MATERIALAUSZUG	Version2 the option for additional payment, pencil case insert for the additional payment of 12 EUR net / gegen Aufpreis, Materialaufsatz Aufschlag: 12 EUR netto		
BASE / WHEELS SOCKEL / ROLLEN	metal base, powder-painted, levelling in the range 20 mm / height 80 mm PLUS wheels white or black, 2 pcs. with a break/2 without a break / Metallsockel, pulverbeschichtet, Nivellierbereich 20 mm / Höhe 80 mm Rollen PLUS, Schwarz bzw. Weiß, 2 Stck. mit Feststeller/2 Stck. ohne Feststeller		
RAILING	under desk containers and high CARGO have the top recessed, in front of the metal rail powder-coated / Untertischcontainer und Apothekerschrank Abdeckplatte versenkt, vorne Railing Metall pulverbeschichtet		
CUSHION / KISSEN	dimension 52x39,5x5,5h cm, for the pedestal 60 cm depth / Abmessungen 52x52x39,5x5,5h cm, für Container 60 cm Breite	made of polyurethane foam of larger density, upholstered / PUR-Schaumstoff mit höherer Dichte, gepolstert	designed to be placed on a top ring of the pedestal, between the sides and the railing - which prevents them from moving / zum Aufsetzen auf dem Oberaufsatz von Container, zwischen den Seiten und dem Reling - so dass sie nicht verrutschen

PEDESTALS / CONTAINER

FINISHING / AUSFÜHRUNG

UNDER-DESK PEDESTALS / UNTERTISCHCONTAINER

GRAIN LAYOUT / FRONTEN ZURUCKZIEHEN

1. TOP RING / ABDECKPLATTE

- MFC / Melamin

2. BODY AND FRONT / KORPUS UND FRONTEN

- MFC / Melamin

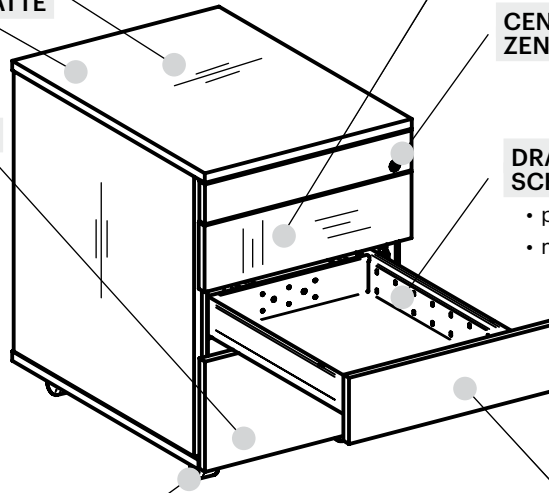

GRAIN LAYOUT / MASERUNG

- lengthwise / horizontal
- crosswise / vertical

CENTRAL LOCK / ZENTRALSCHLOSS

DRAWER INSERTS / SCHUBLADENEINSATZE

- plastic / Kunststoff
- metal / Metall

WHEELS / ROLLEN

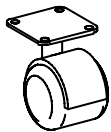

Standard screw-fitted wheels, fi 40 / Ausführung 1 Standardrollen zum Anschrauben, D-40mm

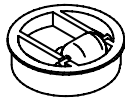

The option for additional payment built in wheels / Kleine Rollen eingesetzt, Gegen Aufpreis 20 EUR

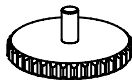

Witch level adjustment within 10 mm / Standcontainer Füße, Niveaueingleich von 10 mm

HANDLES / GRIFFE

- optional / optional

SIDE PEDESTALS / STANDCONTAINER

1. PANEL / ABDECKBODEN

- MFC / Melamin

2. BODY / KORPUS

- MFC / Melamin

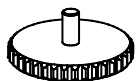

FEET / FUSSE

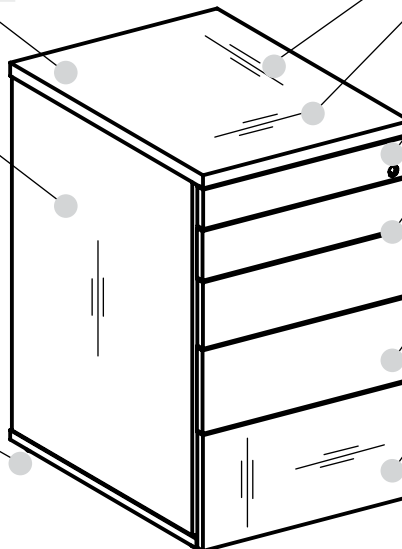

GRAIN LAYOUT / MASERUNG

- lengthwise / horizontal
- crosswise / vertical

CENTRAL LOCK / ZENTRALSCHLOSS

DRAWER INSERTS / SCHUBLADENEINSATZE

- plastic / kunststoff
- metal / metall

HANDLES / GRIFFE

- optional / fakultativ

GRAIN LAYOUT / FRONTENMASERUNG

- lengthwise / langs
- crosswise / quer

PEDESTALS / CONTAINER	PEDESTALS / CONTAINER K2-32, K2-33	PEDESTALS / CONTAINER K2-07, K2-08
1. TOP RING / ABDECKPLATTE FRONT melamine / Melamin-Platte <ul style="list-style-type: none"> • full colour according to BALMA colouring pattern / volle Farben laut BALMA Farbpalette • additional payment / gegen Aufpreis <ul style="list-style-type: none"> - azure blue / Azurblau 1850 body / Korpus + 25 EUR Front + 25 EUR top ring / Abdeckplatte ab K2-11 bis K2-24 + 15 EUR	1. TOP RING / ABDECKPLATTE FRONT melamine / Melamin-Platte <ul style="list-style-type: none"> - natural beech / Buche 0607 - light cherry / helle Kirsche 0705 - white / Weiß 2700 - grey / Lichtgrau 1201 - acacia / Akazie 1520 - natural oak / Natureiche 0400 • other colours – additional payment according the following tabel / andere Farben – gegen Aufpreis laut Tabelle 	1. TOP RING / ABDECKPLATTE FRONT melamine / Melamin-Platte <ul style="list-style-type: none"> - natural beech / Buche 0607 - light cherry / helle Kirsche 0705 - white / Weiß 2700 - grey / Lichtgrau 1201 - acacia / Akazie 1520 - natural oak / Natureiche 0400 • other colours – additional payment according the following tabel / andere Farben – gegen Aufpreis laut Tabelle

NOTE: You can order container with a separate body colours and fronts. In the case of containers K2-32 and K2-33 and K2-07 and K2-08, the following payments: / WICHTIG! Das Dekor von dem Korpus und der Front zur Auswahl gegen Aufpreis, wie z.B: bei K2-32, K2-33, K2-07 und K2-08

ADDITIONAL PAYMENTS FOR COLOURS IN CONTAINERS K2-07, K2-08, K2-32, K2-33 / AUFPREIS BEI DEN CONTAINERN: K2-07, K2-08, K2-32, K2-33

	FRONT	standard	uni	wood/Holz	extra
BODY / KORPUS	COLOUR / FARBE	grey / Grau 1201 natural beech/ Buche 0607 natural oak / Natureiche 0400 light cherry / Helle Kirsche 0705 white / Weiß 2700 acacia / Akazie 1520	sand / Sand 2850 true grey / echtes Grau 1208 deep grey / Tiefes Grau 1205 quartz / Quartz 2424 graphite / Graphit 0300 black / Schwarz 1100 birch / Birke 1500 natural maple / Ahorn Natur 1510 caramel walnut / Karamell Nuss 2360 chocolate walnut / Schokoladen Nuss 2370 black walnut / Schwarznuss 2380	azure blue / Azurblau 1850	
standard	grey / Grau 1201 natural beech / Buche 0607 natural oak / Natureiche 0400 light cherry / Helle Kirsche 0705 white / Weiß 2700 acacia / Akazie 1520	without additional charge / ohne Aufpreise		20 EUR	40 EUR
uni	sand / Sand 2850 true grey / echtes Grau 1208 deep grey / Tiefes Grau 1205 quartz / Quartz 2424 graphite / Graphit 0300 black / Schwarz 1100	20 EUR		40 EUR	60 EUR
wood / Holz	birch / Birke 1500 natural maple / Ahorn Natur 1510 caramel walnut / Karamell Nuss 2360 chocolate walnut / Schokoladen Nuss 2370 black walnut / Schwarznuss 2380				
extra	azure blue / Azurblau 1850	40 EUR		60 EUR	80 EUR

PEDESTALS / CONTAINER

FINISHING / AUSFÜHRUNG

PEDESTALS WITH RAILING / CONTAINER MIT RELING



1. BODY AND TOP RING / KORPUS UND ABDECKPLATTE

- melamine / melaminbeschichtet
- horizontal grain / Masserungsverlauf horizontal

4. RAILING / RELING

- metal, powder-painted / Metall, pulverbeschichtet

LOCK / SCHLOSS

- central lock (2 jack keys) – option / Zentralschloss (2 Knickschlüssel) – optional
- central blockade in drawers / Auszugssperre für Schubladen – optional

2. FRONT

- melamine / melaminbeschichtet
- horizontal or vertical grain / Masserungsnerlauf horizontal bzw. vertikal

4. HANDRAIL SLAT / GRIFFLEISTE

- anodized aluminium or powder-painted / Alu eloxiert bzw. pulverbeschichtet

PLUS PLASTIC WHEELS / KUNSTSTOFFFROLLEN PLUS

- black or white / Weiß bzw. Schwarz

or / oder 4. BASE / SOCKEL

- metal base powder-painted / Metallsockel pulverbeschichtet

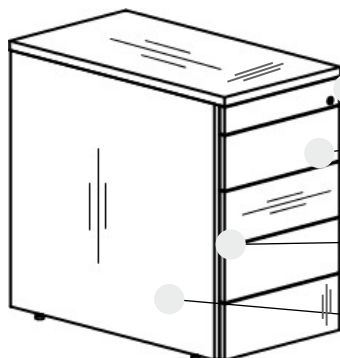

FEET / FÜSSE

- with level adjustment in the range of 10 mm / Niveaueausgleich von 10 mm

LOCK / SCHLOSS

- central lock (2 jack keys) (option) / Zentralschloss (2 Knickschlüssel)
- central blockade in drawers / Auszugssperre für Schubladen – optional

2. FRONT

- melamine / melaminbeschichtet
- horizontal or vertical grain / Masserungsnerlauf horizontal bzw. vertikal

4. HANDRAIL SLAT / GRIFFLEISTE

- anodized aluminium or powder-painted / Alu eloxiert bzw. pulverbeschichtet

1. BODY AND TOP RING / KORPUS UND ABDECKPLATTE

- melamine / melaminbeschichtet
- vertical grain / Masserungsverlauf vertikal
- top ring may be in different colour / Abdeckplatte kann in anderer Farbe sein

CARGO PEDESTAL / CARGO CONTAINER

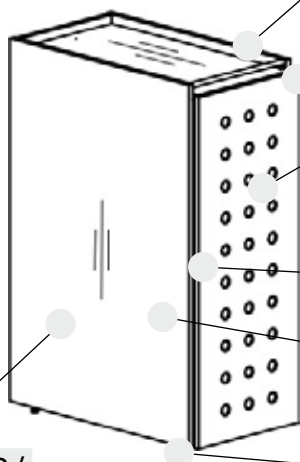

1. BODY AND TOP RING / KORPUS UND ABDECKPLATTE

- melamine / melaminbeschichtet
- vertical grain / Masserungsverlauf vertical

4. RAILING / RELING

- metal, powder-painted / Metall, pulverbeschichtet

LOCK / SCHLOSS

- central lock (2 keys) – option / Zentralschloss (2 Knickschlüssel) – optional

2. FRONT

- melamine (smooth front) / melaminbeschichtet (Front glatt)
- natural veneer (smooth front) / Naturfurnier (Front glatt)
- MDF milled, mat structure varnish / MDF gefräst, Lackbeschichtung matt strukturiert / (milled dimples) / (gefräste Punkten)

4. HANDRAIL SLAT / GRIFFLEISTE

- anodized aluminium or powder-painted / Alu eloxiert bzw. pulverbeschichtet

4. INSIDE OF CONTAINER / CONTAINERRAUM

- powder-painted metal frame / Metallgestell, pulverbeschichtet
- extracting shelf MDF varnished / Ausziehbrett: MDF lackiert

FEET / FÜSSE



- with level adjustment in the range of 10 mm / Nivellierbereich 10 mm

PEDESTAL WITH RAILING / CONTAINER MIT RELING	PEDESTAL CARGO / APOTHEKESCHRANKE	
<p>1. BODY / KORPUS</p> <p>melamine board / melaminbeschichtete Platte</p> <ul style="list-style-type: none"> • full colour range according to BALMA's colour chart / ganze Farbenpalette gem. BALMA-Farbmuster • additional payment / Farben gegen Aufpreis + 25 EUR - azure blue 1850 / Azurblau 1850 <p>2. FRONTS / FRONTEN</p> <p>melamine board / melaminbeschichtete Platte</p> <ul style="list-style-type: none"> • full colour range according to BALMA's colour chart / ganze Farbenpalette gem. BALMA-Farbmuster • additional payment / Farben gegen Aufpreis + 25 EUR - azure blue 1850 / Azurblau 1850 <p>3. POWDER-PAINTED ELEMENTS / PULVERBESCHICHTETE ELEMENTE</p> <p>powder-painted steel / Stahl pulverbeschichtet</p> <ul style="list-style-type: none"> • full colour range according to BALMA's colour chart / ganze Farbenpalette gem. BALMA-Farbmuster <p>4. HAND RAIL SLAT / GRIFFLEISTE</p> <p>anodized Aluminium / Alu eloxiert Aluminium powder-painted additional payment / Aluminium pulverbeschichtet gegen Aufpreis: 25 EUR</p> <ul style="list-style-type: none"> • full colour range according to BALMA's colour chart / ganze Farbenpalette gem. BALMA-Farbmuster 	<p>1. BODY / KORPUS</p> <p>melamine board / melaminbeschichtete Platte</p> <ul style="list-style-type: none"> • full colour range according to BALMA's colour chart / ganze Farbenpalette gem. BALMA-Farbmuster • additional payment / Farben gegen Aufpreis + 25 EUR - azure blue 1850 / Azurblau 1850 <p>3. POWDER-PAINTED ELEMENTS / PULVERBESCHICHTETE ELEMENTE</p> <p>powder-painted steel / Stahl pulverbeschichtet</p> <ul style="list-style-type: none"> • full colour range according to BALMA's colour chart / ganze Farbenpalette gem. BALMA-Farbmuster <p>4. HAND RAIL SLAT / GRIFFLEISTE</p> <p>anodized Aluminium / Alu eloxiert Aluminium powder-painted additional payment / Aluminium pulverbeschichtet gegen Aufpreis: 25 EUR</p> <ul style="list-style-type: none"> • full colour range according to BALMA's colour chart / ganze Farbenpalette gem. BALMA-Farbmuster 	<p>2. FRONTS / FRONTEN</p> <p>melamine board / melaminbeschichtete Platte</p> <ul style="list-style-type: none"> • full colour range according to BALMA's colour chart / ganze Farbenpalette gem. BALMA-Farbmuster • additional payment / Farben gegen Aufpreis + 25 EUR - azure blue 1850 / Azurblau 1850 <p>natural veneer / Naturfurnier</p> <ul style="list-style-type: none"> • full colour range according to BALMA's colour chart / ganze Farbenpalette gem. BALMA-Farbmuster • additional payment / Farben gegen Aufpreis + 50 EUR - milk oak 4544 / Milcheiche 4544 - cocoa oak 4545 / Kakaoeiche 4545 - coffee oak 4546 / Kaffeeeiche 4546 <p>laquered MDF board / MDF Lackbeschichtung strukturiert</p> <ul style="list-style-type: none"> • full colour range according to BALMA's colour chart / ganze Farbenpalette gem. BALMA-Farbmuster • additional payment / Farben gegen Aufpreis + 50 EUR - azure blue X / Azurblau X





PEDESTALS / CONTAINER

PRICES / PREISE

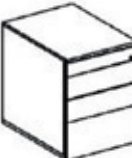

UNDER-DESK PEDESTALS WITHOUT PENCIL CASE / ROLLCONTAINER OHNE MATERIALAUSZUG

VIEW AND PROJECTION OF THE OBJECT / ANSICHT DES OBJEKTS	DIMENSIONS (in cm) / ABMESSUNGEN (in cm)			CATALOGUE NUMBER / PRODUKT-SYMBOL	NET PRICE in EUR / PREIS in €		REMARKS / BEMERKUNGEN
	Width / B	Depth / T	Height (with wheels) / Höhe (mit Rollen)		drawers with plastic inserts / Schubladen mit Kunststoffein-sätzen	drawers with metal inserts / Schubladen mit Metallein-sätzen	
	43	60	62,3	K2-07	207	-	height includes wheels fi 40, plastic drawers, limited colours, no pencil case / Die angegebene Containerhöhe mit den Rollen D-40mm. Kunststoffschubkästen, ohne Materialauszug, Auswahl der Dekore begrenzt
	43	60	62,3	K2-08	207	-	height includes wheels fi 40, plastic drawers, limited colours, no pencil case / Die angegebene Containerhöhe mit den Rollen D-40mm. Kunststoffschubkästen, ohne Materialauszug, Auswahl der Dekore begrenzt





UNDER-DESK PEDESTALS WITH PENCIL DRAWER / ROLLCONTAINER MIT MATERIALAUSZUG

	43	60	56,5	K2-01	258	280	
				K2-02	266	280	
	43	80	56,5	K2-03	334	368	
				K2-04	334	368	

NARROW UNDER-DESK PEDESTALS / SCHMALE ROLLCONTAINER UNTER DEM SCHREIBTISCH



VIEW AND PROJECTION OF THE OBJECT / ANSICHT DES OBJEKTS	DIMENSIONS (in cm) / ABMESSUNGEN (in cm)			CATALOGUE NUMBER / PRODUKT-SYMBOL	NET PRICE in EUR / PREIS in €		REMARKS / BEMERKUNGEN
	Width / B	Depth / T	Height (without wheels) / Höhe (ohne Rollen)		drawers with metal inserts / Schubladen mit Metalleinsätzen		
	33	60	56,5	K2-05	327		
				K2-06	327		



SIDE PEDESTALS (HEIGHT: 72 CM) / STANDCONTAINER (HÖHE: 72 CM)



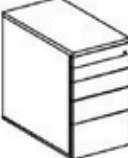

VIEW AND PROJECTION OF THE OBJECT / ANSICHT DES OBJEKTS	DIMENSIONS (in cm) / ABMESSUNGEN (in cm)			CATALOGUE NUMBER / PRODUKT-SYMBOL	NET PRICE in EUR / PREIS in €		REMARKS / BEMERKUNGEN
	Width / B	Depth / T	Height / H		drawers with plastic inserts / Schubladen mit Kunststoffeinsätzen	drawers with metal inserts / Schubladen mit Metalleinsätzen	
	43	60	72	K2-11	344	379	
				K2-12	344	379	
	43	80	72	K2-13	379	413	
				K2-14	379	413	



PEDESTALS / CONTAINER

PRICES / PREISE

SIDE CONTAINERS (HEIGHT: 74 CM) / STANDCONTAINER (HÖHE: 74 CM)							
VIEW AND PROJECTION OF THE OBJECT / ANSICHT DES OBJEKTS	DIMENSIONS (in cm) / ABMESSUNGEN (in cm)			CATALOGUE NUMBER / PRODUKT-SYMBOL	NET PRICE in EUR / PREIS in €		REMARKS / BEMERKUNGEN
	Width / B	Depth / T	Height / H		drawers with plastic inserts / Schubladen mit Kunststoffein-sätzen	drawers with metal inserts / Schubladen mit Metallein-sätzen	
	43	60	74	K2-21	344	379	
				K2-22	344	379	
	43	80	74	K2-23	379	413	
				K2-24	379	413	



CONTAINERS / ROLLCONTAINER						
VIEW AND PROJECTION OF THE OBJECT / ANSICHT DES OBJEKTS	DIMENSIONS (in cm) / ABMESSUNGEN (in cm)			CATALOGUE NUMBER / PRODUKT-SYMBOL	NET PRICE in EUR / PREIS in €	REMARKS / BEMERKUNGEN
	Width / B	Depth / T	Height (with wheels) / Höhe (mit Rollen)			
	43	58	61	K2-32	129	pedestal with the drawer and cabinet, chipboard drawer, handles classic_96 / Container mit einer Schublade aus Melamin, und einem Fach, abschließbar, Griffe classic_96
				K2-33	159	pedestal with three drawers, chipboard drawer, handles classic_96 / Container mit 3 Schubladen aus Melamin, Griffe classic_96





PEDESTALS WITH RAILING / CONTAINER MIT RELING							
VIEW AND PROJECTION OF THE OBJECT / ANSICHT DES OBJEKTS	DIMENSIONS (in cm) / ABMESSUNGEN (in cm)			CATALOGUE NUMBER / PRODUKT-SYMBOL	NET PRICE in EUR / PREIS in €	DESCRIPTION / BESCHREIBUNG	REMARKS / BEMERKUNGEN
	Width / B	Depth / T	Height / H				
	43,2	60	55,5	K2-41	246	under-desk container, 3 drawers, on a PLUS wheels or a base, central lock, 2 keys / Rollcontainer, mit 3 Schubladen, als Rollen-PLUS- bzw. Sockelvariante erhältlich, Zentralschloss, 2 Knickschlüssel, Auszugssperre	-
	43,2	60	55,5	K2-42	246	under-desk container, 1 drawer, 1 hanging files, on a PLUS wheels or a base, central lock, 2 keys / Rollcontainer, mit 1 Schublade und 1 Hängeregistraturrahmen, als Rollen-PLUS- bzw. Sockelvariante erhältlich, Zentralschloss, 2 Knickschlüssel, Auszugssperre	-
	43,2	80	55,5	K2-43	291	under-desk container, on a base, for supporting the desk, 3 drawers, central lock, 2 keys / Standcontainer zur Abstützung des Schreibtisches, 3 x Schubladen, Zentralschloss, 2 Knickschlüssel, Auszugssperre	-
	43,2	80	55,5	K2-44	291	under-desk container, on a base, for supporting the desk, 1 drawer, 1 drawer for hanging files, central lock, 2 keys / Standcontainer zur Abstützung des Schreibtisches, 1 x Schublade, 1 x Hängeregistratur, Zentralschloss, 2 Knickschlüssel, Auszugssperre	-

SIDE CONTAINERS (HEIGHT: 74 CM) / STANDCONTAINER (HÖHE: 74 CM)							
VIEW AND PROJECTION OF THE OBJECT / ANSICHT DES OBJEKTS	DIMENSIONS (in cm) / ABMESSUNGEN (in cm)			CATALOGUE NUMBER / PRODUKT-SYMBOL	NET PRICE in EUR / PREIS in €	DESCRIPTION / BESCHREIBUNG	REMARKS / BEMERKUNGEN
	Width / B	Depth / T	Height / H				
	43,2	80	74	K2-45	362	demountable container, 4 drawers, upper drawer with pencil case, central lock, 2 keys / Standcontainer, 1 x Materialauszug, 3 x Schubladen, Zentralschloss, 2 Knickschlüssel, Auszugssperre	-
	43,2	80	74	K2-46	362	demountable container, 2 drawers, upper drawer with pencil case, 1 drawer for hanging documents, central lock, 2 keys / Standcontainer, 1 x Materialauszug, 2 x Schubladen, 1 x Hängeregistratur, Zentralschloss, 2 Knickschlüssel, Auszugssperre	-

PEDESTALS / CONTAINER

PRICES / PREISE

CARGO-TYPE CONTAINERS / APOTHEKESCHRANKE									
VIEW AND PICTURE / ANSICHT DES OBJEKTES	DIMENSIONS (in cm) / ABMESSUNGEN (in cm)			CATALOGUE NO. / PRODUKT- SYMBOL	NET PRICE IN EUR / NETTOPREIS in €			DESCRIPTION / BESCHREIBUNG	REMARKS / BEMERKUN- GEN
	Width / B	Depth / T	Height / H		body melamine / Korpus MELAMIN				
					front melamine / Front MELAMIN	front natural ve- neer top / Front FURNIER	front MDF mat structure varnish / Front MDF Lackiert matt		
	43,2	80	115	K2-51	688	872	888	CARGO, on feet, lock, 2 jack keys / Apothekerschrank hoch, Sockelva- riante, Schloss, 2 Knickschlüssel	standard equipment: hanging files' frames. Additional equipment on page 59 / Standar- dausstattung: Hängeregis- terrahmen. Zusätzliche Ausstattung auf S.58
	43,2	80	74	K2-52	562	779	797	CARGO, on feet, lock, 2 jack keys / Apothekerschrank klein, Sockelva- riante, Schloss, 2 Knickschlüssel	

CARGO EQUIPMENT / APOTHEKESCHRANK-AUSSTATTUNG								
VIEW AND PICTURE / ANSICHT DES OBJEKTES	DIMENSIONS (in cm) / ABMESSUNGEN (in cm)			CATALOGUE NO. / PRODUKT- SYMBOL	NET PRICE IN EUR / NETTOPREIS in €	DESCRIPTION / BESCHREIBUNG	REMARKS / BEMERKUN- GEN	
	Width / B	Depth / T	Height / H					
	33	68	4	K2-501	22	CARGO equipment: tray, powder-painted metal / Apotheker- schrank-Ausstattung: Tablett, Metall, pulver- beschichtet	to put on the upper rail, func- tion of pencil case / auf den Apotheker- schrank	
	34	36	35,5	K2-502	174	CARGO equipment: varnished MDF box / Apothekerschran- k-Ausstattung: Kasten aus MDF lackiert matt	4 boxes for CARGO K2-51, 2 boxes for K2-52 / für K2-51 maxi- mal 4 St., für K2-52 maximal 2 St.	
	32	34	0,1	K2-503	14	CARGO equipment: box shelf K2-502, powder-painted metal, 1 pcs / Apothekerschran- k-Ausstattung: Brett für den Kasten K2-502, Metall pulverbeschich- tet, 1 Stck.	5 shelves for one box / für K2-502 maxi- mal 5 Boden zu einem Kasten	
	32	32	10	K2-504	20	CARGO equipment: box drawer K2-502, powder-painted metal, 1 pcs / Apothekerschran- k-Ausstattung: Schublade für den Kasten K2-502, Metall pulverbeschich- tet, 1 Stck.	3 drawers for one box / für K2-502 maxi- mal 3 Schubla- den zu einem Kasten	

Examples: / Beispiele:

- box with shelves / 1. Einsatz mit Einlegeböden
1 × K2-502 + 5 × K2-503 price 239 EUR net / netto
- box with drawers / 2. Einsatz mit Einlegeböden
1 × K2-502 + 3 × K2-504 price 231 EUR net / netto

ADDITIONAL DRAWERS EQUIPMENT / ZUSÄTZLICHE SCHUBLADENACCESSOIRES

VIEW AND PICTURE / ANSICHT DES OBJEKTES	DIMENSIONS (in cm) / ABMESSUNGEN (in cm)			CATALOGUE NO. / PRODUKTSYMBOL	NET PRICE IN EUR / NETTOPREIS in €		REMARKS / BEMERKUNGEN
	Width / B	Depth / T	Height / H				
	34	2	7	K2-103	5		divider to share space in the drawer / Trennelement
	33	4	21	K2-101	5		document-compartment insert, 1 item for combinations / Dokumenteneinsatz, 1 Stck., reihenfähig
	33	0,6	15	K2-102	3		locking element for document-compartment insert / Abschlusselement für den Dokumenteneinsatz
	Example: / Beispiel: 4 x K2-101 + 1 x K2-102 price / Preis 23 EUR net / netto						
	33,5	19,6	2,4	K2-104	12		pencil case hole in a drawer / Stiftablage

CUSHION / SITZKISSEN

VIEW AND PICTURE / ANSICHT DES OBJEKTES	DIMENSIONS (in cm) / ABMESSUNGEN (in cm)			CATALOGUE NO. / PRODUKTSYMBOL	NET PRICE IN EUR / NETTOPREIS in €		REMARKS / BEMERKUNGEN
	Width / B	Depth / T	Height / H		fabric group A (BALMA) / Gewebe Gr. A (BALMA)	fabric Agava (BALMA) / Gewebe Agava (BALMA)	
	43	60	4	K2-100	74	99	minimal order refers to the multiple of 2 items of the same material and colour / Bestellmengen ab 2 Stück in dem gleichen Stoff

CUSHION / SITZKISSEN

VIEW AND PICTURE / ANSICHT DES OBJEKTES	DIMENSIONS (in cm) / ABMESSUNGEN (in cm)			CATALOGUE NO. / PRODUKTSYMBOL	NET PRICE IN EUR / NETTOPREIS in €					REMARKS / BEMERKUNGEN
	Width / B	Depth / T	Height / H		fabric group / Stoff Gruppe					
					A	B	C	D	F	
	52	39,5	5,5	P4-646	166	215	231	314	447	pillow for the pedestal with railing / Kissen für Container mit Railing