



Executive furniture Chefzimmerprogramm

XEON

Executive office furniture collection
Chefzimmerprogramm

design: Piotr Kuchciński

XEON executive office furniture collection designed by Piotr Kuchciński is a break-through in the current BALMA offer. It has been carefully created for the most demanding customer who takes care of the design and high quality furniture. Exceptional shapes of desks and tables' frames, interesting solutions of cabinets, and the combination of glass, natural veneer and steel, make the collection outstanding. The shapes of desktops are an interesting element in the XEON collection because of their milled edges and finishing - they are made of dark graphite tempered glass or natural oak veneer in three colours: milk oak, cocoa oak and coffee oak. Whereas the frames are made of bent powder painted steel profiles, and the feet of stainless steel. The cabinets of unique shapes, interesting finishing and rare lengths available in natural oak veneers make an unforgettable impression. The collection is completed by comfortable set of sofas. In order to create complete solution for the office, special interior decoration elements have been created.

Die durch Piotr Kuchcinski entworfene Kollektion Xeon wurde an die Bedürfnisse des Kunden mit hohen Anforderungen angepasst, der gleichzeitig Originalität des Designs und Qualität der Möbel schätzt. Das charakteristische Merkmal dieser Kollektion ist ihre Variationsmöglichkeit was die Innenausstattung bzw. Einrichtung anbetrifft. Der Benutzer hat eine Bandbreite von Möglichkeiten in der Zusammenstellung des Angebots aus Schreibtischen, Tischen, Schränken und Kommoden und kann darüber hinaus auf ein ebenso breites Angebot von originellen ACCESSORIES, Lampen und Sofas zurückgreifen. Die Formen der Schreibtischgestelle und Tische, die interessanten Lösungen der zum Set gehörenden Schränke sowie die Verarbeitung von Glas, Furnier und Stahl spiegeln die edlen Merkmale der ganzen Kollektion wieder. Die Furnierelemente der Möbel werden in drei verschiedenen interessanten Farbvarianten angeboten.

COLLECTION ELEMENTS / ELEMENTE DER KOLLEKTION

DESKS AND TABLES / SCHREIBTISCHE UND TISCHE

WORKING DESK / TISCHPLATTE	Version 1 25mm MDF board with milled edges, finished with modified natural veneer oak / 25mm MDF Furnier Eiche modifiziert; gefräste Kanten	Version 2 10mm tempered glass / 10 mm Hartglas
FRAME / GESTELL	metal powder painted of circular crossing section 30 mm / Metall rund D-30 mm, pulverbeschichtet	
FEET / FÜSSE	feet made from chromium plated steel with level adjustment / Füße verchromt mit Bodenausgleich	

COFFEE TABLES / ANSATZTISCHE

TOP / TISCHPLATTE	25 mm MDF board finished with modified natural veneer oak / MDF-Platte 25mm, Furnier Eiche modifiziert
FRAME / GESTELL	metal, powder painted, flexural made from wire of rectangular crossing section 20x8 mm / Metall rechteckig 20x8 mm, pulverbeschichtet

CABINETS / SCHRÄNKE UND KOMMODEN

FRONT / FRONTEN	Version 1 lacquered MDF board / MDF-Platte lackiert	Version 2 18 mm MDF board finished with modified natural veneer oak / 18mm MDF Furnier Eiche modifiziert	Version 3 glass type satinato or graphite, in the frame made from anodized aluminum (only cabinet No X11) / Satinglas oder Graphitglas in einem Alurahmen (nur bei Kommode X11)
BODY / KORPUS	25 mm MDF board finished with modified natural veneer oak / MDF-Platte 25mm, Furnier Eiche modifiziert		
BACK WALL / RÜCKWAND	double lacquered MDF board or natural veneer to strengthen the construction of the cabinet / Doppelte MDF Platte, lackiert oder Furnier als Verstärkung der Schränkenkonstruktion		
INTERNAL ELEMENTS / INNENAUSSATTUNG	shelves: MDF board finished with modified natural veneer oak (shelves) or lacquered (cabinets) / Ablagen: furnierte (Regale) oder lackierte (Schränke) MDF Platte		
	metal drawer type Innotech (HETTICH) with full pull out and the system called Silent (silent closing) / Metall, pulverbeschichtet. Schubladen Innotech (HETTICH) mit vollem Auszug und dem Silent System		
	doors with hinges type Intermat (HETTICH) / Scharniere (HETTICH)		
	hanging cabinets contain front gas lift / In den Hängeschränken – Klappenfront		
FEET / FÜSSE	feet made from chromium plated steel with level adjustment / Bodenausgleich verchromt		

ACCESSORIES

ACCESSORIES	casket, pencil case, paper tray / Truhe, Stiftablege, Papiertablett	
CLOTHE HANGER / GARDEROBENSTÄNDER	polished stainless steel, circular cross section / Metall rund, pulverbeschichtet	
WALL PANELS / WANDPANELEE	MDF 25 mm / MDF 25 mm	
	Version 1 MDF prepared for painting / MDF ohne Lack	Version 2 set of 2, 4, 6 or 8 panels MDF in 1 colour according Balma sample book – lacquer structure. Each set has on the back panel made of MDF thickness 18 mm with hangers. Standard arrangement according a drawing in the price list. Modification possible accord a drawing or arrangement from the client

COLLECTION ELEMENTS / ELEMENTE DER KOLLEKTION

DESKS AND TABLES / SCHREIBTISCHE/TISCHE

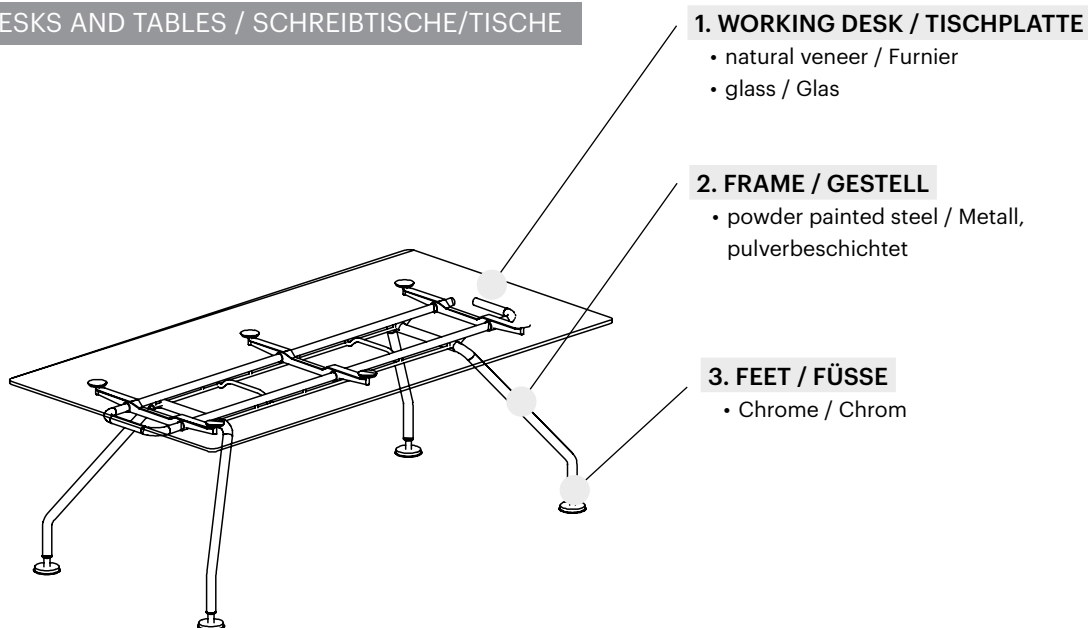

COFFEE TABLES / ANSATZTISCHE

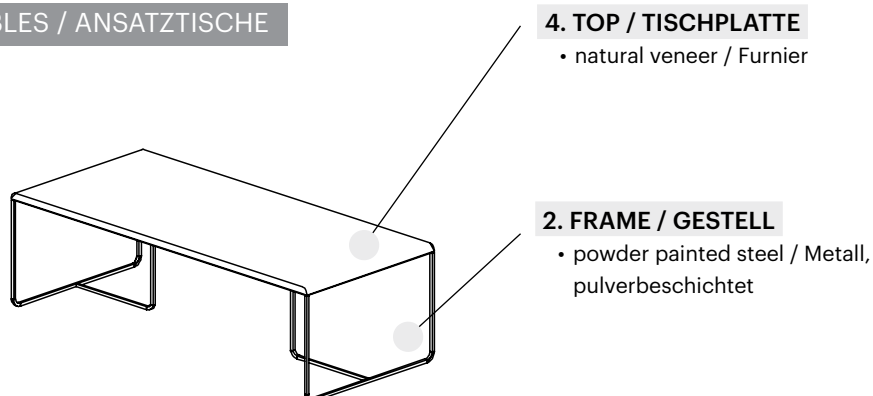

CABINETS AND PEDESTALS / CONTAINER UND SIDEBOARDS

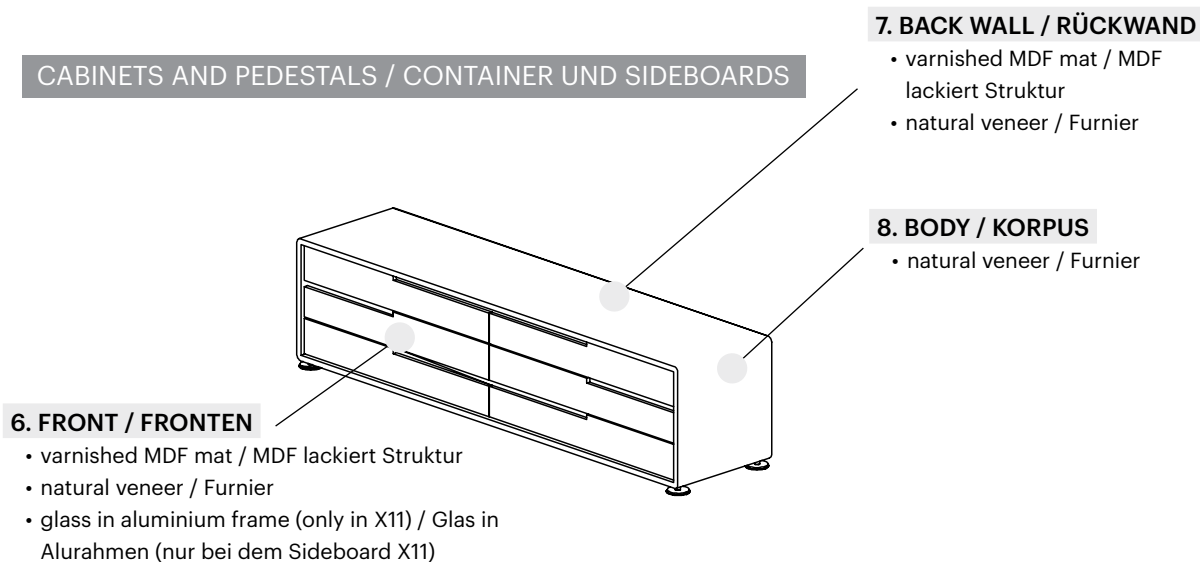

COLLECTION ELEMENTS / ELEMENTE DER KOLLEKTION

DESKS AND TABLES / SCHREIBTISCHE UND TISCHE

1. WORKING DESK / TISCHPLATTE

natural veneer / Naturfurniere

- milk oak / Milcheiche 4544
- cacao oak / Kakaoeiche 4545
- coffee oak / Kaffeeeiche 4546
- natural oak / Natureiche 4900
- laquered white oak / Eiche schwarz lackiert 4949
- laquered black oak / Eiche schwarz lackiert 4950

glass / Glas

- graphite / graphit
- clear / klar

2. FRAME / GESTELL

powder painted steel / Metall, pulverbeschichtet

- new quartz / Neues Quartz RAL 7022
- white mat / Matt weiß 9003
- black / schwarz RAL 9005

COFFEE TABLES / ANSATZTISCHE

1. TOP / TISCHPLATTE

natural veneer / Naturfurniere

- milk oak / Milcheiche 4544
- cacao oak / Kakaoeiche 4545
- coffee oak / Kaffeeeiche 4546
- natural oak / Natureiche 4900
- laquered white oak / Eiche schwarz lackiert 4949
- laquered black oak / Eiche schwarz lackiert 4950

2. FRAME / GESTELL

powder painted steel / Metall, pulverbeschichtet

- new quartz / Neues Quartz RAL 7022
- white mat / Matt weiß 9003
- black / schwarz RAL 9005

CABINETS AND PEDESTALS / CONTAINER UND SIDEBBOARD

5. FRONT / FRONTEN

varnished MDF mat / MDF lackiert Struktur

- black mat / Matt schwarz B
- white mat / Matt weiß R
- new quartz / Neues Quartz S
- natural veneer / Naturfurniere
- milk oak / Milcheiche 4544
- cacao oak / Kakaoeiche 4545
- coffee oak / Kaffeeeiche 4546
- natural oak / Natureiche 4900
- laquered white oak / Eiche schwarz lackiert 4949
- laquered black oak / Eiche schwarz lackiert 4950

glass / Glas*

- satinato
- graphite / graphit

*in the frame made from anodized aluminum (only cabinet No X11) / in einem Alurahmen (nur bei dem Sideboard X11)

6. BACK WALL / RÜCKWAND

varnished MDF mat / MDF lackiert Struktur



- black mat / Matt schwarz B
- white mat / Matt weiß R
- new quartz / Neues Quartz S









7. BODY / KORPUS

natural veneer / Naturfurniere





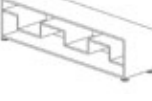
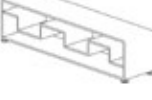

- milk oak / Milcheiche 4544
- cacao oak / Kakaoeiche 4545
- coffee oak / Kaffeeeiche 4546
- natural oak / Natureiche 4900
- laquered white oak / Eiche schwarz lackiert 4949
- laquered black oak / Eiche schwarz lackiert 4950



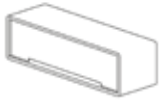
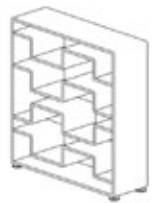
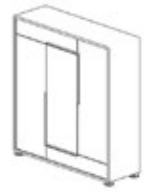





PRICES / PREISE

DESKS / SCHREIBTISCHE							
VIEW AND PROJECTION OF THE OBJECT / ANSICHT DES OBJEKTS	DIMENSIONS (in cm) / ABMESSUNGEN (in cm)			CATALOGUE NUMBER / PRODUKT-SYMBOL	NET PRICE in EUR (without VAT) / NETTOPREIS in €		REMARKS / BEMERKUNGEN
	WIDTH / BREITE	DEPTH / TIEFE	HEIGHT / HÖHE		MELAMINE 25mm / MELAMIN 25mm	GLASS / GLAS	
	160	80	74	X35	1 339	1 476	
	180	90		X36	1 433	1 638	
	210	110		X01	1 654	1 985	
	277	125		X02	2 270	2 585	
	110	110		X03	1 154	1 268	
	217	255/ 165	74	X04	1 725	1 927	Possibility of assembling the cabinet type: X09, X10, X11, X12, X13, X37, X38. Desktop Dimensions 210x110 cm / Möglichkeit der Montage X09, X10, X11, X12, X13, X37, X38. Tischplatte 210x110 cm
				X05	1 725	1 927	

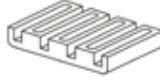
CABINETS / SIDEBBOARD						
VIEW AND PROJECTION OF THE OBJECT / ANSICHT DES OBJEKTS	DIMENSIONS (in cm) / ABMESSUNGEN (in cm)			CATALOGUE NUMBER / PRODUKT-SYMBOL	NET PRICE in EUR / NETTOPREIS in €	REMARKS / BEMERKUNGEN
	WIDTH / BREITE	DEPTH / TIEFE	HEIGHT / HÖHE			
	230	55	57	X09	3584	Six drawers cabinet with natural veneer fronts / Sideboard mit 6 Schubladen und furnierten Fronten
				X10	2001	Five drawers cabinet with natural veneer fronts / Sideboard mit 5 Türen, Fronten furniert
				X11	3237	Cabinet with sliding doors made of glass available in colouring: satinato or graphite / Sideboard mit SchiebeGlastüren, (Satin oder Graphit)
	140	55	57	X12	2140	Three drawers cabinet with natural veneer fronts / Sideboard mit 3 Schubladen, Fronten furniert
	95	55	57	X37	1784	
	140	55	57	X13	1335	Cabinet with 3 doors finished with natural veneer / Sideboard mit 3 Türen, Fronten furniert
	95	55	57	X38	1044	Cabinet with 2 doors finished with natural veneer / Sideboard mit 2 Türen, Fronten furniert
	230	55	57	X14	2374	Bookcase shelves and trunk finished with natural veneer and lacquered back wall / Korpus und Ablagen furniert, Rückwand lackiert
			41	X15	1803	
	140	55	57	X16	1596	Bookcase shelves and trunk finished with natural veneer and lacquered back wall / Korpus und Ablagen furniert, Rückwand lackiert

PRICES / PREISE

HANGING CABINET / HÄNGESCHRÄNKE						
VIEW AND PROJECTION OF THE OBJECT / ANSICHT DES OBJEKTS	DIMENSIONS (in cm) / ABMESSUNGEN (in cm)			CATALOGUE NUMBER / PRODUKT-SYMBOL	NET PRICE in EUR (without VAT) / NETTOPREIS in €	REMARKS / BEMERKUNGEN
	WIDTH / BREITE	DEPTH / TIEFE	HEIGHT / HÖHE			
	140	43	38	X17	912	Hanging cabinet with lacquered MDF front / Hängeregal mit Türen (MDF-Platte lackiert)
BOOKCASES / SCHRÄNKE						
	140	43	150	X18	2889	Bookcase shelves and trunk finished with natural veneer. Backwall lacquered MDF or natural veneer. / Korpus und Ablagen furniert. Rückwand furniert oder MDF lackiert. Rückwand lackiert
	140	43	150	X19	3337	Cabinet with lacquered MDF front and shelves. Backwall lacquered MDF or natural veneer. / Aktenschrank, Fronten und Ablagen MDF-Platte, lackiert. Rückwand furniert oder MDF lackiert
COFFEE TABLES / TISCHE						
	57	57	57	X06	604	
	100	100	23	X07	1088	
	80	80	23	X39	876	
	60	60	23	X40	757	
	140	60	40	X08	641	

ACCESSORIES / ACCESSOIRES						
	50	50	150	X34	593	Hanger / Garderoben- ständer
	34	34	7	X20	213	Paper tray. Beech wood stained walnut / Papiertablett. Auf Nuss- baum gefärbte Buche, Massivholz
	34	34	7	X21	256	Pencil case. Beech wood stained walnut. / Stiftablage. Auf Nuss- baum gefärbte Buche, Massivholz
	34	34	8	X22	246	Casket. Beech wood stained walnut. / Truhe. Auf Nussbaum gefärbte Buche, Massivholz
	60	2,5	60	X24	42	Wall panel not lacquer- ed, to be finished in- dividually / Wandpaneel ohne Lack
	120	4,3	60	X-41	168	Set of 2 panels with 2 hangers / Set mit 2 Pa- nels zum 2 Aufhängen
	120	4,3	120	X-42	330	Set of 4 panels with 4 hangers / Set mit 4 Pa- nels zum 4 Aufhängen
	180	4,3	120	X-43	490	Set of 6 panels with 6 hangers / Set mit 6 Pa- nels zum 6 Aufhängen
	240	4,3	120	X-44	646	Set of 8 panels with 8 hangers / Set mit 8 Panels zum 8 Aufhängen

