



**Executive furniture and workstations
Chefzimmerprogramm und Arbeitsplätze**

SIMPLIC

Collection of conference tables and desks
Konferenztische und Schreibtische

design: Piotr Kuchciński

Simplic is a range of conference tables and desks. It is distinguished by its unique simplicity of form and construction, its universal and flexible applications and its high degree of comfort.

The range consists of single conference tables in a wide range of shapes and sizes, modular conference tables, workstations and executive desks which can be supported on cabinets or pedestals and complementary low coffee tables. The original and sophisticated aesthetics of the Simplic range combined with the variety of multifunctional applications also benefits from a wide range of finishes which allows the furniture to be used in a wide range of interior solutions.

Simplic ist eine Kollektion von Konferenz- und Schreibtischen. Sie zeichnet sich aus durch ihre einzigartige Einfachheit der Form und Konstruktion, ihre universelle und flexible Anwendbarkeit und ihren hohen Grad an Komfort. Das Sortiment besteht aus einzelnen Konferenztischen in vielfältigen Formen und Größen, modularen Konferenztischen, Arbeitsplätzen und Chefzimmerschreibtischen, aufgestützt auf Kommoden oder sich ergänzenden, niedrigen Kaffeetischen.

Die original und hochentwickelte Ästhetik der Simplic Kollektion verbunden mit der Vielfalt der multifunktionalen Anwendbarkeit zieht ihren Nutzen aus dem großen Sortiment an Oberflächenausführungen und ermöglicht den Möbeln in vielfältigen Inneneinrichtungslösungen genutzt zu werden.

COLLECTION ELEMENTS / ELEMENTE DER KOLLEKTION

CONFERENCE TABLES / KONFERENZTISCHE						
DESKTOP / TISCHPLATTE	Version 1 natural veneer on board 25mm milled edges / Furnier - Plattenstärke 25mm, gefräste Kanten	Version 2 HPL on plywood 25mm thick, milled edges / Spanplatte 25mm, HPL, gefräste Kanten	Version 3 foil on MDF board 25mm thick / MDF-Platte 25mm, PCV Folie	Version 4 melamine MFC 25mm thick / Melaminplatte 25mm	Version 5 tempered glass 10mm, lacquered on the left side / Hartglas 10mm, lackiert (von unten)	
	Round corners of desktops / Kanten abgerundet					
DESKTOP / TISCHPLATTE S1-01 AND / UND S1-08	DIVIDED / GETEILTE PLATTE				ONE PIECE / GANZE PLATTE	
	Version 1 natural veneer on board 25mm milled edges / Furnier - Plattenstärke 25mm, gefräste Kanten	Version 2 HPL on plywood 25mm thick, milled edges / Spanplatte 25mm, HPL, gefräste Kanten	Version 3 foil on MDF board 25mm thick / MDF-Platte 25mm, PCV Folie	Version 4 melamine MFC 25mm thick / Melaminplatte 25mm	Version 5 tempered glass 10mm, lacquered on the left side / Hartglas 10mm, lackiert (von unten)	
FRAME / GESTELL	Frame powder painted made of metal plate 2mm / Gestell pulverbeschichtet - Blech Stärke 2 mm					
	Version 1 Frame and legs powder painted / Metall pulverbeschichtet Tischbeine		Version 2 Frame powder painted, legs chromium steel, more price 65 EUR per each leg / Traverse Metall pulverbeschichtet, Füße - verchromt gegen Aufpreis von 65 € / 1 Stück			
	Vertical cable duct (in the leg) / Vertikale Kabelführung (in den Tischfüßen)					
FOOT / FUSS	Feet made from chromium aluminium • Levelling in range of 10mm / Füße - Aluminium vechromt • Bodenausgleich 10mm					

MODULAR CONFERENCE TABLES / MODULKONFERENZTISCHE			
DESKTOP / TISCHPLATTE	Version 1 NATURAL VENEER on board 25mm thick, milled edges / FURNIER Plattenstärke 25mm, gefräste Kanten	Version 2 foil on MDF board 25mm thick / MDF-Platte 25mm, PCV Folie	Version 3 melamine MFC 25mm thick / Melaminplatte 25mm
	Round corners of desktops / Ecken abgerundet		
	Desktops joint with a middle leg / Tischplatten mit Stützfuß verbinden		
FRAME / GESTELL	Frame powder painted made of metal plate 2mm / Gestell pulverbeschichtet - Blech Stärke 2 mm		
	Version 1 Frame and legs powder painted / Traverse und Füße, Metall pulverbeschichtet		Version 2 Frame powder painted, legs chromium steel, more price 65 EUR per each leg / Traverse Metall pulverbeschichtet, Füße - verchromt gegen Aufpreis von 65EUR/ 1 Stück
	Vertical cable duct (in the leg) / Vertikale Kabelführung (in den Tischfüßen)		
FOOT / FUSS	Feet made from chromium aluminium • Levelling in range of 10mm / Füße - Aluminium vechromt • Bodenausgleich 10mm		

COLLECTION ELEMENTS / ELEMENTE DER KOLLEKTION

DESKS / SCHREIBTISCHE				
DESKTOP / TISCHPLATTE	Version 1 natural veneer on board 25mm, Milled edge / Furnier MDF-Platte 25mm, gefräste Kanten	Version 2 foil on MDF board 25mm thick / MDF-Platte 25mm, PCV Folie	Version 3 melamine MFC 25mm thick / Melaminplatte 25mm	Version 4 HPL on plywood 25mm thick, milled edges / Spannplatte 25mm, HPL, gefräste Kanten
	Round corners of desktops / Ecken abgerundet			
FRAME / GESTELL	Frame powder painted made of metal plate 2mm / Gestell pulverbeschichtet - Blech Stärke 2 mm			
	Version 1 Frame and legs powder painted / Metall, Tischbeine - pulverbeschichtet		Version 2 Frame powder painted, legs chromium steel, more price 65 EUR per each leg / Traverse Metall pulverbeschichtet, Füße - verchromt gegen Aufpreis von 65EUR/ 1 Stück	
	Vertical cable duct (in the leg) / Vertikale Kabelführung (in den Tischfüßen)			
FOOT / FUSS	Feet made from chromium aluminium • Leveling in range of 10mm / Füße - Aluminium verchromt • Bodenausgleich 10mm			

COFFEE TABLES / ANSATZTISCHE					
DESKTOP / TISCHPLATTE	Version 1 natural veneer on board 25mm milled edges / Furnier - Plattenstärke 25mm, gefräste Kanten	Version 2 HPL on plywood 25mm thick, milled edges / Spannplatte 25mm, HPL, gefräste Kanten	Version 3 foil on MDF board 25mm thick / MDF-Platte 25mm, PVC- Folie	Version 4 melamine MFC 25mm thick / Melaminplatte 25mm	Version 5 lacquered MDF 25mm, milled edges / lackiertes MDF 25mm, gefräste Kanten
	Round corners of desktops / Ecken abgerundet				
FRAME / GESTELL	Frame powder painted made of metal plate 2mm / Gestell pulverbeschichtet - Blech Stärke 2 mm				
	Version 1 Frame and legs powder painted / Metall, Tischbeine - pulverbeschichtet			Version 2 Frame powder painted, legs chromium steel, more price 65 EUR per each leg / Traverse Metall pulverbeschichtet, Füße - verchromt gegen Aufpreis von 65EUR/ 1 Stück	
FOOT / FUSS	Feet made from chromium aluminium • Leveling in range of 10mm / Füße - Aluminium verchromt • Bodenausgleich 10mm				

MOBILE CABINETS 10K07-10K18 / AUFSATZSCHRÄNKE / SCHRÄNKE 10K07-10K18				
BODY / KORPUS	18 and 25mm melamine chipboard (MFC) / Melamin Plattenstärke 18mm und 25mm			
BACK WALL / RÜCKWAND	18 melamine chipboard (MFC) / Melamin Plattenstärke 18mm			
TOP RING / ABDECKPLATTE	25 melamine chipboard (MFC) / Melamin Plattenstärke 25mm			
DRAWERS / SCHUBLADEN	silent system, metal sides of drawers silent system, Metallschubladen			
FRONT / FRONTEN	natural veneer / Furnier	Varnished MDF mat / MDF lackiert Struktur	foil / Folie PCV	melamine / Melaminplatte
HANDLES / GRIFFE	no handles, part of the drawers' front in the function of handle / Ohne Griffe - Funktion der Griffe übernimmt das herausstehende Teil der Schubladenfront			

COLLECTION ELEMENTS / ELEMENTE DER KOLLEKTION

CABINETS AND PEDESTAL S1-39 - S1-41 / SCHRÄNKE UND CONTAINER S1-39 - S1-41

BODY / KORPUS	MDF 25mm, top ring 25mm , rounded edges / MDF Plattenstärke 18mm und 25 mm, Kanten abgerundet		
MATERIAL	natural veneer / Furnier	Varnished MDF mat / MDF lackiert Struktur	
DRAWERS / SCHUBLADEN	drawers' sides metal, system push-to-open, bottom of the drawers MFC / Metallschubladen, System „push to open“, Boden aus Melamin		
BOTTOM RING / SOCKEL	metal bottom ring, lever adjustment in range of 10mm / Metallsockel, Bodenausgleich 10mm		

PARTITION SCREENS / TRENNWÄNDE

FRAME / GESTELL	metal fi 16 mm, powder painted / Metall, D=16 mm, pulverbeschichtet		
FABRICS / GEPOLSTERT	Version 1 mesh / Netz	Version 2 fabric / Stoff AGAVA	Version 3 fabric / Stoff NEXT

SCREENS / TRENNWÄNDE

FRAME / GESTELL	metal fi 22 mm, powder painted / Metall, D=22 mm, pulverbeschichtet
FABRICS / GEPOLSTERT	mesh / Netz
FOOT / FUSS	steel powder painted or chromium plated / Metall, pulverbeschichtet, verchromt

FRONT SHIELD / FRONTBLENDE

MATERIAL	Version 1 natural veneer on board 18mm / Furnier - Plattenstärke 18mm	Version 2 Ribbed Silver HPL lami- nated chipboard 18MM, co- lour: silver / Riffellaminat + MDF-Platte 18mm, silber	Version 3 melamine MFC 18mm thick / Mela- minplatte 18mm
NOTE / WICHTIG!	assembled to the frame with metal plate, powder painted / An dem Gestell befestigt, Winkelleisten pulverbeschichtet		

COLLECTION ELEMENTS / ELEMENTE DER KOLLEKTION

DESKS / SCHREIBTISCHE • CONFERENCE TABLES / KONFERENZTISCHE

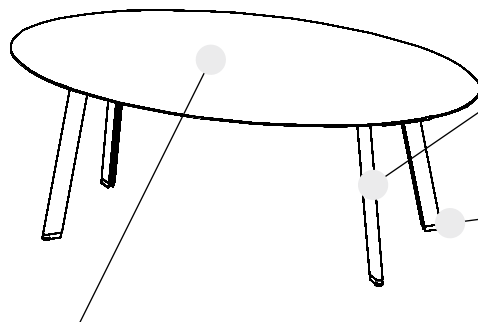

1. DESKTOP / TISCHPLATTE

- natural veneer / Furnier
- HPL on plywood / HPL Speerholz
- foil / Folie
- melamine / Melaminplatte
- glass lacquered on the left side / Glas lackiert (von unten)



2. FRAME / GESTELL

- powder painted steel / Traverse Metall, pulverbeschichtet
- legs chrome / Tischbeine verchromt

3. FEET / FÜSSE

- chromium aluminium / verchromt Aluminium

EDGE / KANTEN

-  • melamine / Melaminplatte
-  • varnished MDF mat / MDF lackiert Struktur (milled edge / gefräste Kanten)
- natural veneer / Furnier (milled edge / gefräste Kanten)
- foil / Folie (milled edge / gefräste Kanten)

MOULAR CONFERENCE TABLES / MODULKONFERENZTISCHE

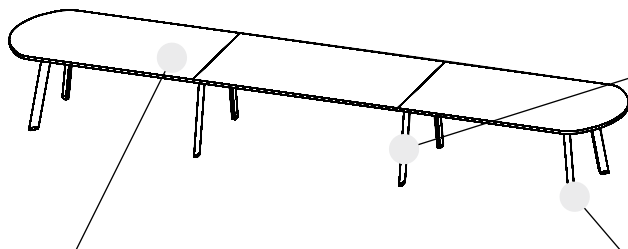

4. DESKTOP / TISCHPLATTE

- natural veneer / Furnier
- foil / Folie
- melamine / Melaminplatte

2. FRAME / GESTELL

- powder painted steel / Metall, pulverbeschichtet
- legs chrome / Tischbeine Chrom

3. FEET / FÜSSE

- chromium aluminium / Aluminium verchromt

COFFEE TABLES / ANSATZTISCHE

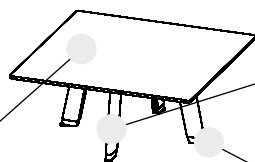

5. DESKTOP / TISCHPLATTE

- natural veneer / Furnier
- HPL on plywood / HPL Speerholz
- foil / Folie
- varnished MDF mat / MDF lackiert Struktur
- melamine / Melaminplatte

2. FRAME / GESTELL

- powder painted steel / Traverse Metall, pulverbeschichtet

3. FEET / FÜSSE

- chromium aluminium / Aluminium verchromt

COLLECTION ELEMENTS / ELEMENTE DER KOLLEKTION

DESKS AND TABLES / SCHREIBTISCHE UND TISCHE

1. WORKING DESK / TISCHPLATTE

melamine board / Melamin

- full colour according to BALMA colouring pattern / alle Farben des BALMA Materialmuster
- 10% additional payment / Aufpreis +10%
 - juicy green / Blattgrün 1750
 - azure blue / Azurblau 1850

natural veneer / Naturfurniere

- full colour according to BALMA colouring pattern / alle Farben des BALMA Materialmuster
- 10% additional payment / Aufpreis +10%
 - milk oak / Milcheiche 4544
 - cacao oak / Kakaoeiche 4545
 - coffee oak / Kaffeeeiche 4546

HPL

- black / schwarz
- white / weiß
- juicy green / Blattgrün 1750
- azure blue / Azurblau 1850

foil / Folie

- oak / Eiche 3600
- light walnut / helle Nuss 3200
- dark walnut / dunkle Nuss 3100

glass lacquered on the left side / Glas lackiert (von unten)

- white / weiß (possible to assemble diode lighting, transparent for light / Beleuchtung unter der Tischplatte möglich)
- black / schwarz (not transparent / nicht Klarglas)

- 10% additional payment / Aufpreis +10%
 - juicy green / Blattgrün Y
 - azure blue / Azurblau X

MOULAR TABLES / MODULKONFERENZTISCHE

4. WORKING DESK / TISCHPLATTE

melamine board / Melamin

- full colour according to BALMA colouring pattern / alle Farben des BALMA Materialmuster
- 10% additional payment / Aufpreis +10%
 - juicy green / Blattgrün 1750
 - azure blue / Azurblau 1850

natural veneer / Naturfurniere

- full colour according to BALMA colouring pattern / alle Farben des BALMA Materialmuster
- 10% additional payment / Aufpreis +10%
 - milk oak / Milcheiche 4544
 - cacao oak / Kakaoeiche 4545
 - coffee oak / Kaffeeeiche 4546

foil / Folie

- oak / Eiche 3600
- light walnut / helle Nuss 3200
- dark walnut / dunkle Nuss 3100

2. FRAME / GESTELL

DESKS, TABLES, COFFEE TABLES

powder painted steel / Metall, pulverbeschichtet

- full colour according to BALMA colouring pattern / alle Farben des BALMA Materialmuster
- OPTION: legs chromium steel, more price 65 EUR per each leg / Füße - verchromt gegen Aufpreis von 65EUR/ 1 Stück

3. FEET / FÜßE

chrominium aluminum / verchromt Aluminium

COFFEE TABLES / ANSATZTISCHE

5. WORKING DESK / TISCHPLATTE

melamine board / Melamin

- full colour according to BALMA colouring pattern / alle Farben des BALMA Materialmuster
- 10% additional payment / Aufpreis +10%
 - juicy green / Blattgrün 1750
 - azure blue / Azurblau 1850

natural veneer / Naturfurniere

- full colour according to BALMA colouring pattern / alle Farben des BALMA Materialmuster
- 10% additional payment / Aufpreis +10%
 - milk oak / Milcheiche 4544
 - cacao oak / Kakaoeiche 4545
 - coffee oak / Kaffeeeiche 4546

foil / Folie

- oak / Eiche 3600
- light walnut / helle Nuss 3200
- dark walnut / dunkle Nuss 3100

HPL

- black / schwarz
- white / weiß
- juicy green / Blattgrün 1750
- azure blue / Azurblau 1850

varnished MDF mat / MDF lackiert Struktur

- black mat / Matt schwarz B
- light grey / Lichtgrau E
- white mat / Matt weiß R
- new quartz / Neues Quartz S
- sand mat / Matt Sand TS
- deep grey / Tiefes Grau U
- dark graphite / Intensives Grafit W
- true grey / echtes Grau Z
- 10% additional payment / Aufpreis +10%
 - azure blue / Azurblau X
 - juicy green / Blattgrün Y

FINISHING / AUSFÜHRUNG

SZAFKI DOSTAWNE / SZAFKI 10K07- 10K18

1. FRONTY

- okleina naturalna
- folia
- MDF lakier
- melamina

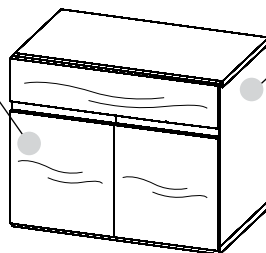

2. KORPUS

- melamina

3. ŻALUZJA

- tworzywo sztuczne

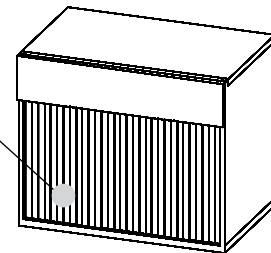

SZAFKI I KONTENERY S1-39 - S1-41

4. WYKOŃCZENIE

- okleina naturalna
- MDF lakier mat

5. COKÓŁ

- metal

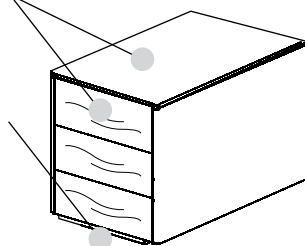

PARAWAN

8. TAPICERKA

- siatka

7. STELAŻ

- stal lakierowana

9. STOPKI

- stal lakierowana
- chrom

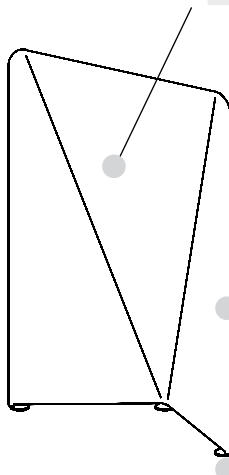

ŚCIANKI MIĘDZYBIURKOWE

7. STELAŻ

- stal lakierowana

6. TAPICERKA

- siatka
- tkanina AGAVA
- tkanina NEXT

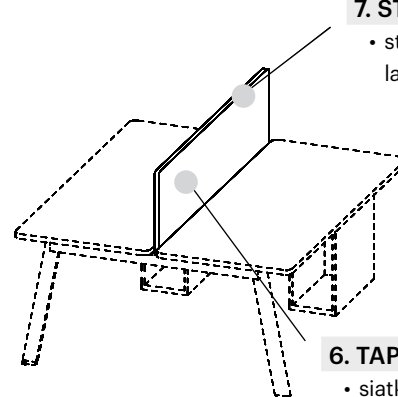

SZAFKI DOSTAWNE / SZAFKI 10K07-10K18

1. FRONTY

płyta melaminowana

- pełna kolorystyka wg wzornika BALMA
- kolory za dopłatą 10%
 - liściasta zieleń 1750
 - lazurowy niebieski 1850

okleina naturalna

- pełna kolorystyka wg wzornika BALMA
- kolory za dopłatą 10%
 - dąb mleczny 4544
 - dąb kakaowy 4545
 - dąb kawowy 4546

folia

- dąb 3600
- orzech jasny 3200
- orzech ciemny 3100

MDF lakier struktura

- pełna kolorystyka wg wzornika BALMA

2. KORPUS

płyta melaminowana

- pełna kolorystyka wg wzornika BALMA
- kolory za dopłatą 10%
 - liściasta zieleń 1750
 - lazurowy niebieski 1850

3. ŻALUZJA

tworzywo sztuczne

- srebrna
- popiel
- czarna
- antracyt
- biała

PARAWAN

8. TAPICERKA

siatka

- biały
- czarny

9. STOPKI

stal malowana proszkowo

- pełna kolorystyka wg wzornika BALMA
- chrom

7. STELAŻ

stal malowana proszkowo

- biały satyna 9016
- biały mat 9003
- piaskowy
- srebrny metalik mat
- srebrny połysk
- głęboki popiel RAL 7037
- nowy kwarc RAL 7022
- mocny grafit RAL 7021
- ciemny brąz RAL 8022
- czarny RAL 9005
- lazurowy niebieski
- liściasta zieleń

SZAFKI I KONTENERY S1-39-S1-41

4. WYKOŃCZENIE

okleina naturalna

- pełna kolorystyka wg wzornika BALMA
- kolory za dopłatą 10%
 - dąb mleczny 4544
 - dąb kakaowy 4545
 - dąb kawowy 4546

MDF lakier struktura

- pełna kolorystyka wg wzornika BALMA

5. COKÓŁ

stal malowana proszkowo

- pełna kolorystyka wg wzornika BALMA

ŚCIANKI MIĘDZYBIURKOWE

6. TAPICERKA

siatka

- biały
- czarny















tkanina Agava

- kolorystyka wg NOTI

tkanina NEXT

- kolorystyka wg PROFIM

PRICES / PREISE

CONFERENCE TABLES / KONFERENZTISCHE											
VIEW AND PROJECTION OF THE OBJECT / ANSICHT DES OBJEKTS		DIMENSIONS (in cm) / ABMESSUNGEN (in cm)			CATALOGUE NUMBER / PRODUKT-SYMBOL	NET PRICE in EUR / NETTOPREIS in €					REMARKS / BEMERKUNGEN
		WIDTH / BREITE	DEPTH / TIEFE	HEIGHT / HÖHE		NATURAL VENEER / FURNIER	HPL / HPL	GLASS / GLAS	FOIL / FOLIE	MELAMINE / MELAMIN	
		Ø180		74	S1-01	1019*	-	1380**	843*	557*	*top divided **top one piece / *Tischplatte in 3 Teilen **Tischplatte ganz
		Ø135		74	S1-02	737	-	1252	-	463	
		Ø110		74	S1-03	519	778	894	453	333	
		277	135	74	S1-04	1131	-	2102	-	632	top one piece / Tischplatte ganz
		220	120	74	S1-05	1042	-	1678	762	555	
		277	135	74	S1-06	1160	-	2129	-	629	
		220	120	74	S1-07	905	-	1678	762	522	
		160	160	74	S1-08	908*	-	1304**	769*	532*	*top divided **top one piece / *Tischplatte in 3 Teilen **Tischplatte ganz
		135	135	74	S1-09	751	-	1221	-	476	
		110	110	74	S1-15	621	881	942	553	425	top one piece / Tischplatte ganz
		277	125	74	S1-10	1090	-	1909	-	602	

CONFERENCE TABLES AND DESKS / KONFERENZTISCHE											
		220	110	74	S1-11	884	-	1549	754	528	
		200	100		S1-12	796	1228	1460	687	495	
		180	90		S1-13	713	1064	1388	626	464	
		160	80		S1-14	640	916	1317	570	436	









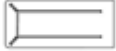

COFFEE TABLES / TISCHE

VIEW AND PROJECTION OF THE OBJECT / ANSICHT DES OBJEKTS	DIMENSIONS (in cm) / ABMESSUNGEN (in cm)			CATALOGUE NUMBER / PRODUKT-SYMBOL	NET PRICE in EUR / NETTOPREIS in €					REMARKS / BEMERKUNGEN	
	WIDTH / BREITE	DEPTH / TIEFE	HEIGHT / HÖHE		NATURAL VENEER / FURNIER	HPL / HPL	GLASS / GLAS	FOIL / FOLIE	MELAMINE / MELAMIN		
		100	100	40	S1-16	522	722	532	454	348	
		Ø80		40	S1-17	460	578	395	404	327	
		150	60	40	S1-18	511	737	461	458	352	

MODULAR CONFERENCE TABLES 125CM DEEP / MODULKONFEREZTISCHE 125CM-TIEFE

VIEW AND PROJECTION OF THE OBJECT / ANSICHT DES OBJEKTS	DIMENSIONS (in cm) / ABMESSUNGEN (in cm)			CATALOGUE NUMBER / PRODUKT-SYMBOL	NET PRICE in EUR / NETTOPREIS in €			REMARKS / BEMERKUNGEN	
	WIDTH / BREITE	DEPTH / TIEFE	HEIGHT / HÖHE		NATURAL VENEER / FURNIER	FOIL / FOLIE	MELAMINE / MELAMIN		
		220	125	74	S1-19	757	609	379	End module. Edge on one end rounded / Endungselement Tischkanten abgerundet
		155	125	74	S1-20	385	481	313	
		205	125	74	S1-22	529	393	194	Middle module. Straight edges / Mittelelement Gerade Kanten
		135	125	74	S1-23	344	254	123	
		205	125	74	S1-24	728	589	386	End module. Edges on one end slightly rounded / Endungselement Tischkanten gerundet
		135	125	74	S1-25	717	579	364	
		60	95	70	S1-21	220			Middle leg / Verbindungsfuß

PRICES / PREISE

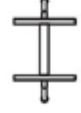
MODULAR CONFERENCE TABLES 90CM DEEP / MODULKONFEREZTISCHE 90CM-TIEFE									
VIEW AND PROJECTION OF THE OBJECT / ANSICHT DES OBJEKTS		DIMENSIONS (in cm) / ABMESSUNGEN (in cm)			CATALOGUE NUMBER / PRODUKT-SYMBOL	NET PRICE in EUR / NETTOPREIS in €			REMARKS / BEMERKUNGEN
		WIDTH / BREITE	DEPTH / TIEFE	HEIGHT / HÖHE		NATURAL VENEER / FURNIER	FOIL / FOLIE	MELAMINE / MELAMIN	
		205	90	74	S1-26	583	484	321	End module. Edges on one end slightly rounded / Endelement Tischkanten abgerundet
		135	90	74	S1-27	441	376	263	
		205	90	74	S1-29	403	302	157	Middle module. Straight edges. / Mittelelement Kanten gerade
		135	90	74	S1-30	262	194	101	
		205	90	74	S1-31	583	484	321	Middle module. To be assembled between extension and middle module. Straight Edg / Mittelelement Zur Montage zwischen Verbindung und anderem Mittelteil. Kanten gerade
		135	90	74	S1-32	441	376	263	
		90	90	-	S1-33	207	180	141	Extension 90 / Verbindungsstück 90
		205	90	74	S1-34	435	334	185	Extension 135 / Verbindungsstück 135
		205	90	74	S1-35	766	665	485	Middle module. To be assembled between two extensions. Straight edges / Mittelelement zwischen zwei Verbindungen, Kanten gerade
	135	90	74	S1-36	663	557	427		
		60	80	70	S1-28	213		Middle leg / Verbindungsfuß	

EXECUTIVE DESKS SUPPORTED ON CABINETS / KLEINE SCHRÄNKE UND CONTAINER

VIEW AND PROJECTION OF THE OBJECT / ANSICHT DES OBJEKTS	DIMENSIONS (in cm) / ABMESSUNGEN (in cm)			CATALOGUE NUMBER / PRODUKT-SYMBOL	NET PRICE in EUR / NETTOPREIS in €		REMARKS / BEMERKUNGEN
	WIDTH / BREITE	DEPTH / TIEFE	HEIGHT / HÖHE		NATURAL VENEER* / FURNIER*	LACQUERED MDF / MDF LACKIERT	
	155	50	53	S1-39	1716	1548	Cabinet with three doors and metal bottom ring, doors and drawers "push to open" / Schrank mit 2 Türen und 3 Schubladen
	46	70	53	S1-40	1325	1255	Pedestal with drawers, "push to open" / Container mit Schubladen
	46	70	53	S1-41	1325	1255	Pedestal with drawers and filing frame, "push to open" / Container mit Schublade, Hängeregistratur

*horizontal grain layout * waagerechte Maserung

EXECUTIVE DESKS SUPPORTED ON CABINETS / SCHREIBTISCHE AUF KOMMODEN AUFGESETZT

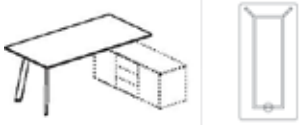
VIEW AND PROJECTION OF THE OBJECT / ANSICHT DES OBJEKTS	DIMENSIONS (in cm) / ABMESSUNGEN (in cm)			CATALOGUE NUMBER / PRODUKT-SYMBOL	NET PRICE in EUR / NETTOPREIS in €				REMARKS / BEMERKUNGEN
	WIDTH / BREITE	DEPTH / TIEFE	HEIGHT / HÖHE		NATURAL VENEER / FURNIER	HPL / HPL	FOIL / FOLIE	MELAMINE / MELAMIN	
	200	100	74	S1-37	629	1061	520	386	Executive desk to be supported on a cabinet or a pedestal / Schreibtisch zum Aufsetzen auf einem Schrank oder Container
	180	90	74	S1-38	547	897	459	355	

SINGLE DESKS TO BE SUPPORTED ON SIDE CABINETS / EINZELSCHREIBTISCH AUFGESETZT AUF EINEM SCHRANK

	200	80	74	S1-42	593	936	505	356	Desk supported on 2 legs perpendicular to desktop. Price does not include the cabinet / Schreibtisch mit 2 Füßen Preis ohne Schrank
	180	80	74	S1-43	548	858	469	334	
	160	80	74	S1-44	505	780	435	312	
	140	80	74	S1-45	467	709	405	298	
	120	80	74	S1-46	430	637	378	283	

PRICES / PREISE

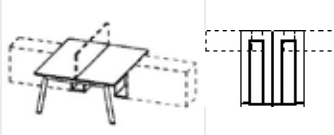

DOUBLE DESKS TO BE SUPPORTED ON MIXT SIDE CABINETS / DOPPELSCHREIBTISCHE AUFGESETZT AUF EINEM SCHRANK

VIEW AND PROJECTION OF THE OBJECT / ANSICHT DES OBJEKTS	DIMENSIONS (in cm) / ABMESSUNGEN (in cm)			CATALOGUE NUMBER / PRODUKT-SYMBOL	NET PRICE in EUR / NETTOPREIS in €				REMARKS / BEMERKUNGEN
	WIDTH / BREITE	DEPTH / TIEFE	HEIGHT / HÖHE		NATURAL VENEER / FURNIER	HPL / HPL	FOIL / FOLIE	MELAMINE / MELAMIN	
	200	163	74	S1-47	974	1278	609	514	desk supported on 2 legs vertical to desktop, price does not include the cabinet / Doppelschreibtisch mit 2 Füßen Preis ohne Schrank
	180	163	74	S1-48	687	1168	566	483	
	160	163	74	S1-49	823	1387	683	453	
	140	163	74	S1-50	573	1240	625	420	
	120	163	74	S1-51	516	835	434	390	





EXTENSION DESK / SCHREIBTISCHANSATZ

	100	60	74	S1-76	324	455	291	226	
--	-----	----	----	--------------	-----	-----	-----	-----	--

SIDE CABINETS / ANSTELLSCHRÄNKE ZU SCHREIBTISCHEN







VIEW AND PROJECTION OF THE OBJECT / ANSICHT DES OBJEKTS	DIMENSIONS (in cm) / ABMESSUNGEN (in cm)			CATALOGUE NUMBER / PRODUKT-SYMBOL	NET PRICE in EUR / NETTOPREIS in €		REMARKS / BEMERKUNGEN
	WIDTH / BREITE	DEPTH / TIEFE	HEIGHT / HÖHE		MELAMINE / MALAMIN		
	28	48	65	10K05	72		internal dimensions: 23x50x49Hcm / Schrank aus Melaminplatte. Innenmaß 23x50x49Hcm
	23	2,5	55	14K36	46		metal cover for 10K05 / Metall Schutzblende zum 10K05
	43	58	62	S1-82	291		pedestal on castors, three drawers, 1 pencil case, bottom of drawers melamine (MFC), no handle / S1-82 Container ohne Griffe, Materialauszug, 3 Schubladen aus Melamin
	43	58	62	S1-82	291		pedestal on castors, 1 drawer, 1 drawer for suspension files, 1 pencil case, bottom of drawers melamine (MFC), no handle / S1-02 Container ohne Griffe, Materialauszug, Schublade, Hängeregistratur

MIXT SIDE CABINETS / ANSTELLSCHRÄNKE ZU SCHREIBTISCHEN

VIEW AND PROJECTION OF THE OBJECT / ANSICHT DES OBJEKTS	DIMENSIONS (in cm) / ABMESSUNGEN (in cm)			CATALOGUE NUMBER / PRODUKT-SYMBOL	NET PRICE in EUR / NETTOPREIS in €				REMARKS / BEMERKUNGEN
	WIDTH / BREITE	DEPTH / TIEFE	HEIGHT / HÖHE		FRONT: MELAMINE* / FRONT: MELAMIN	FRONT: FOIL* / FRONT: FOLIE	FRONT: LACQUER / FRONT: LACK	FRONT: NATURAL VENEER* / FRONT: FURNIER	
	80	50	65	10K07	346*	373*	409	423*	jalousie cabinet, drawer in upper part, left or right hand opening, handle required. / Rolladen schrank, Schublade, Rollade links-oder rechts Griffe zur Auswahl
	120	50	65	10K08	441*	475*	507	526*	
	80	50	65	10K09	298*	359*	313	355*	cabinet with doors, drawer in upper part, fronts of drawer and doors the same. / Flügeltüren schrank, Schublade, Tür Links-oder Rechts
	120	50	65	10K10	397*	486*	438	475*	

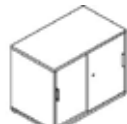
*horizontal grain layout / * horizontale Maserung

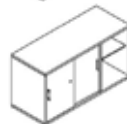
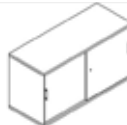
PRICES / PREISE

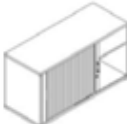
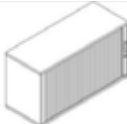
SIDE CABINETS / ANSTELLSCHRÄNKE ZU SCHREIBTISCHEN						
VIEW AND PROJECTION OF THE OBJECT / ANSICHT DES OBJEKTS	DIMENSIONS (in cm) / ABMESSUNGEN (in cm)			CATALOGUE NUMBER / PRODUKT-SYMBOL	NET PRICE in EUR / NETTOPREIS in €	REMARKS / BEMERKUNGEN
	WIDTH / BREITE	DEPTH / TIEFE	HEIGHT / HÖHE		MELAMINE / MELAMIN	
	80	48	65	10K11	136	To suport a desk / Ansatzregal um den Schreibtisch zu befestigen
	120	48	65	10K12	196	To suport a desk / Ansatzregal um den Schreibtisch zu befestigen
	80	48	65	10K13	227	Cabinet with sliding door / Schiebetürschrank
 	120	48	65	10K14 RIGHT / RECHTS 10K14 LEFT / LINKS	275	Cabinet with slipping door to support a desk on the side with open shelves / Schiebetürschrank um den Schreibtisch zu befestigen von der Regalseite
	120	48	65	10K15	297	Cabinet with sliding door / Schiebetürschrank
	80	48	65	10K16	281	Jalousie cabinet / Rolladenschrank
 	120	48	65	10K17 RIGHT / RECHTS 10K17 LEFT / LINKS	349	Jalousie cabinet with open shelves to suport desk on the side / Rolladenschrank um den Schreibtisch zu befestigen von der Regalseite
	120	48	65	10K18	367	Jalousie cabinet / Rolladenschrank

FRONT SHIELD FOR CONFERENCE TABLES / KNEIBLENDEN FÜR MODULTISCHE

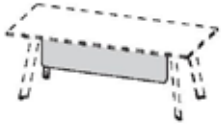
VIEW AND PROJECTION OF THE OBJECT / ANSICHT DES OBJEKTS	DIMENSIONS (in cm) / ABMESSUNGEN (in cm)			CATALOGUE NUMBER / PRODUKT-SYMBOL	NET PRICE in EUR / NETTOPREIS in €			REMARKS / BEMERKUNGEN
	WIDTH / BREITE	DEPTH / TIEFE	HEIGHT / HÖHE		NATURAL VENEER / FURNIER	HPL / HPL	MELAMINE / MELAMIN	
	195	1,8	35	S1-52	145	180	54	For table S1-22, S1-29/ Zum Schreibtisch S1-22, S1-29
	170			S1-53	129	159	48	For table S1-19, S1-24, S1-26, S1-31 / Zum Schreibtisch S1-19, S1-24, S1-26, S1-31
	145			S1-54	112	138	44	For table S1-35 / Zum Schreibtisch S1-35
	125			S1-55	101	120	41	For table S1-23, S1-30 / Zum Schreibtisch S1-23, S1-30
	100			S1-56	83	101	36	For table S1-20, S1-25, S1-27, S1-32 / Zum Schreibtisch S1-20, S1-25, S1-27, S1-32
	75			S1-57	66	81	31	For table S1-36 / Zum Schreibtisch

FRONT SHIELD FOR CONFERENCE TABLES / KNEIBLENDEN FÜR MODULTISCHE

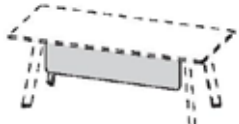
	165	1,8	35	S1-58	127	155	48	For desk S1-37 / Zum Schreibtisch S1-37
	145			S1-59	112	138	50	For desk S1-38 / Zum Schreibtisch S1-38
	180			S1-60	136	167	51	For desk S1-42 / Zum Schreibtisch S1-42
	160			S1-61	122	151	48	For desk S1-11, S1-43 / Zum Schreibtisch S1-11, S1-43
	140			S1-62	109	133	44	For desk S1-12, S1-44 / Zum Schreibtisch S1-12, S1-44
	120			S1-63	95	140	46	For desk S1-13, S1-45 / Zum Schreibtisch S1-13, S1-45
	100			S1-64	84	101	35	For desk S1-14, S1-46 / Zum Schreibtisch S1-14, S1-46

PRICES / PREISE

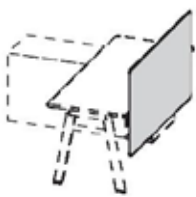

SCREENS FOR SINGLE DESKS / TRENNWÄNDE FÜR EINZELSCHREIBTISCHE

VIEW AND PROJECTION OF THE OBJECT / ANSICHT DES OBJEKTS	DIMENSIONS (in cm) / ABMESSUNGEN (in cm)			CATALOGUE NUMBER / PRODUKT-SYMBOL	NET PRICE in EUR / NETTOPREIS in €			REMARKS / BEMERKUNGEN
	WIDTH / BREITE	DEPTH / TIEFE	HEIGHT / HÖHE		NATURAL VENEER / FURNIER	HPL / HPL	MELAMINE / MELAMIN	
	190	2	75	S1-65	171	489	298	For desks 200cm wide / Zum Schreibtisch 200cm-Breite
	170			S1-66	160	447	276	For desks 180cm wide / Zum Schreibtisch 180cm-Breite
	150			S1-67	147	401	248	For desks 160cm wide / Zum Schreibtisch 160cm-Breite
	130			S1-68	137	358	215	For desks 140cm wide / Zum Schreibtisch 140cm-Breite
	110			S1-69	126	316	202	For desks 120cm wide / Zum Schreibtisch 120cm-Breite

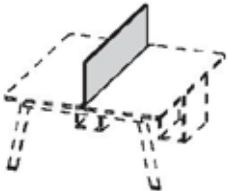
SCREENS FOR DOUBLE DESKS / TRENNWÄNDE FÜR DOPPELSCHREIBTISCHE

	190	2	40	S1-70	140	301	209	For desks 200cm wide / Zum Schreibtisch 200cm-Breite
	170			S1-71	120	265	179	For desks 180cm wide / Zum Schreibtisch 180cm-Breite
	150			S1-72	115	242	166	For desks 160cm wide / Zum Schreibtisch 160cm-Breite
	130			S1-73	106	216	149	For desks 140cm wide / Zum Schreibtisch 140cm-Breite
	110			S1-74	101	193	137	For desks 120cm wide / Zum Schreibtisch 120cm-Breite

ACCESSORIES / ZUBEHÖR

VIEW AND PROJECTION OF THE OBJECT / ANSICHT DES OBJEKTS	DIMENSIONS (in cm) / ABMESSUNGEN (in cm)			CATALOGUE NUMBER / PRODUKT-SYMBOL	NET PRICE in EUR / NETTOPREIS in €		REMARKS / BEMERKUNGEN
	WIDTH / BREITE	DEPTH / TIEFE	HEIGHT / HÖHE				
	120	42	172	S1-75	414 laquered feet / Füße lackiert	435 chrome feet / Füße verchromt	Screen, metal frame, upholstered with mesh. available colours: black and white. / Wandschirm, Metallgestell mit Netz, weiss oder schwarz
	43	25	53	S1-77	367		PC holder, metal powder painted. internal dimensions: 34x21x51Hcm / Computertablet, Metall pulverbeschichtet Innenmaß 34x21x51Hcm