



**Executive furniture
Chefzimmerprogramm**

Meritum

Executive set of office furniture
Chefzimmerprogramm

design: Piotr Kuchciński

The MERITUM combines discreet smartness with classical form what gives full satisfaction to group of manager type people who admire prestige and individuality. The MERITUM set includes elements, which enable freedom in creating functional managerial working station, which ensure comfort during long hours.

Das Chefzimmer MERITUM birgt in sich eine diskrete Eleganz in klassischer Form, ermöglicht auf ganzer Linie Zufriedenheit für Personen, die Prestige und Individualität schätzen. Diese Kollektion besteht aus Teilen, die es erlauben, eine grosse Ungezwungenheit unter Schaffung eines funktionellen Chefzimmers zu ermöglichen und sogar einen gewissen Komfort entstehen zu lassen, wenn es sich um vielstündliche Arbeit handelt.

COLLECTION ELEMENTS / ELEMENTE DER KOLLEKTION

DESKS, TABLES, EXTENTION DESKS / SCHREIBTISCHE, TISCHE, ANSTATTZTISCHE

DESKTOP / TISCHPLATTE	top desk - foiled 38mm MDF board / Tischplatte – MDF 38 mm Folie
	bottom desk – 12 mm varnished MDF board / Untere Platte – MDF 12 mm lackiert
FRAME / GESTELL	site frames 44mm milled varnished MDF plates / Füße, MDF Platte 44 mm, gefräst, lackiert
	legs connection construction – 18mm varnished MDF board, in M5 is used 29mm MDF board / Verbindungskonstruktion MDF 18 mm, lackiert (bei M5 MDF 29 mm)

PEDESTALS / CONTAINER

DRAWERS / SCHUBLADEN	Version 1 pencil case, three drawers / Materialauszug, 3 Schubladen	Version 2 pencil case, 1 drawer, file frame / Materialauszug, 2 Schubladen, Hängerregistratur
	FRONT: foiled MDF 18mm / FRONTEN: MDF 18mm, Foile	
	metal insert drawers / Schubladeneinsätze, Metall, pulverbeschichtet	
	blockade preventing from pulling out more than one drawer / Ausziehsperre	
	central lock / Zentralschlverschluss	
BODY / KORPUS	18 mm melamine chipboard finished with PVC edge band / Melaminplatte, 18 mm, PVC-Kanten	
TOP RING / ABDECKPLATTE	top of pedestal - milled and foiled 38 mm MDF board, 12 mm varnished MDF board / Korpus: MDF 38 mm, gefräst, Folie + MDF 12 mm lackiert	

CABINETS / SCHRÄNKE

TYPES / PRODUKT	file cabinet, with glass door, wardrobe, open shelves / Schrank für Kühlschrank, Schrank mit Glastür, Aktenschrank, Garderobenschrank	
BODY / KORPUS	18 mm melamine chipboard / Melaminplatte 18 mm	
FRONT / FRONTEN	Version 1 MDF 18mm, foiled / MDF 18mm Folie	Version 2 glass door: 5mm tempered glass / Glastür: Hartglas 5 mm
ADDITIONAL INFORMATION/ ZUSÄTZLICHE INFORMATIONEN	level adjustment / Bodenausgleich	
	secura shelf support / Einlegeböden	
	128 width metal satin handles / Satin Griffe 128 mm	
	soft closing slat / Seite soft close	only for cabinets with plate doors / bei Aktenschränken ohne Glasfronten
	3 point lock / Drehverschluss	In cabinets with plate doors of height 30H and higher / Bei Aktenschränken 30H
NOTE! / WICHTIG!	TOP RINGS FOR THE CABINETS SHOULD BE ORDERED SEPARATELY / ABDECKPLATTE FÜR SCHRÄNKE SEPARAT BESTELLEN!	

TOP CABINETS RINGS / ABDECKPLATTE BEI DEN SCHRÄNKEN

TOP RING / ABDECKPLATTE	Top desk – foiled 38 mm MDF board / Platte - MDF 38 mm Folie
	Bottom desk – 12 mm varnished MDF board / Untere Platte - MDF 12 mm lackiert

FINISHING / AUSFÜHRUNG

DESKS TABLES EXTENTION DESKS /SCHREIBTISCHE TISCHE ANSÄTZE

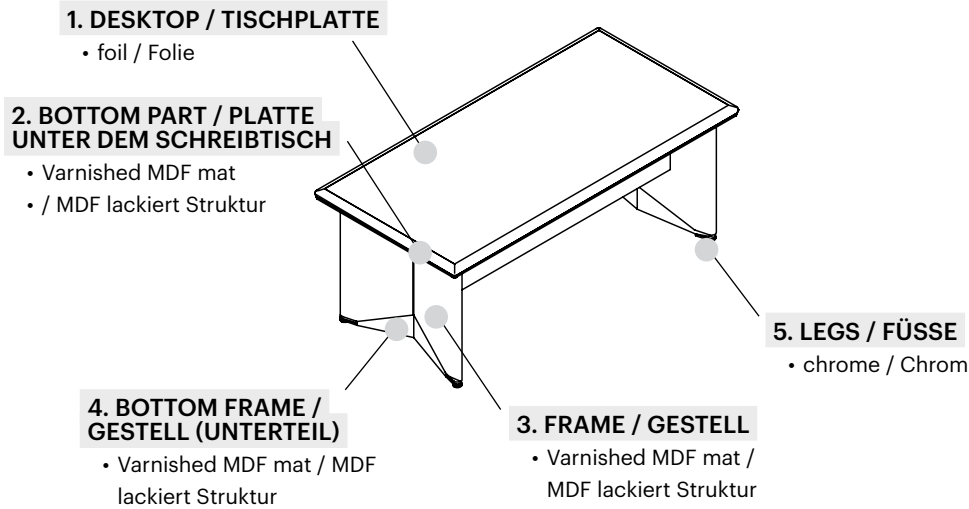

PEDESTALS / CONTAINER

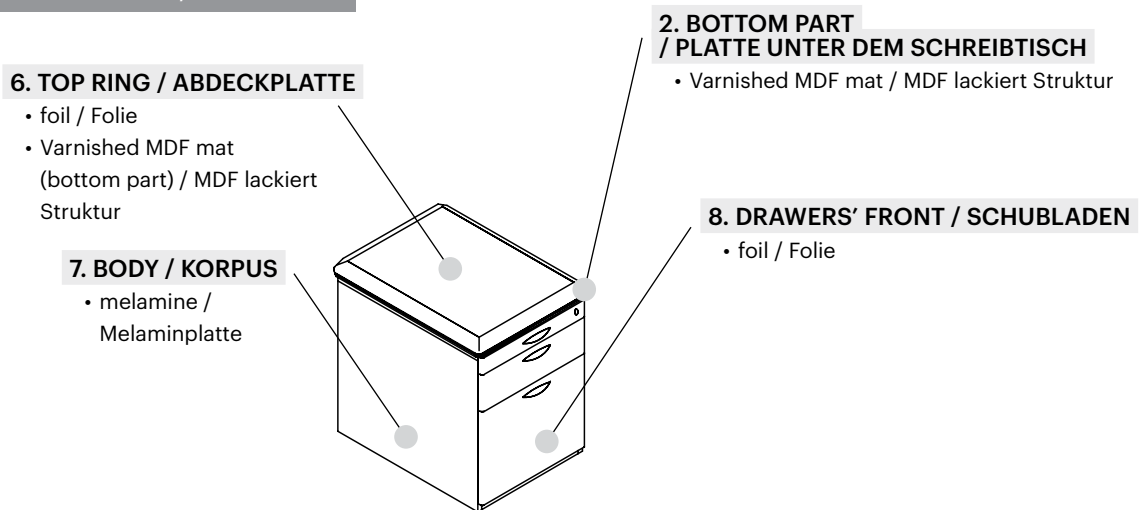



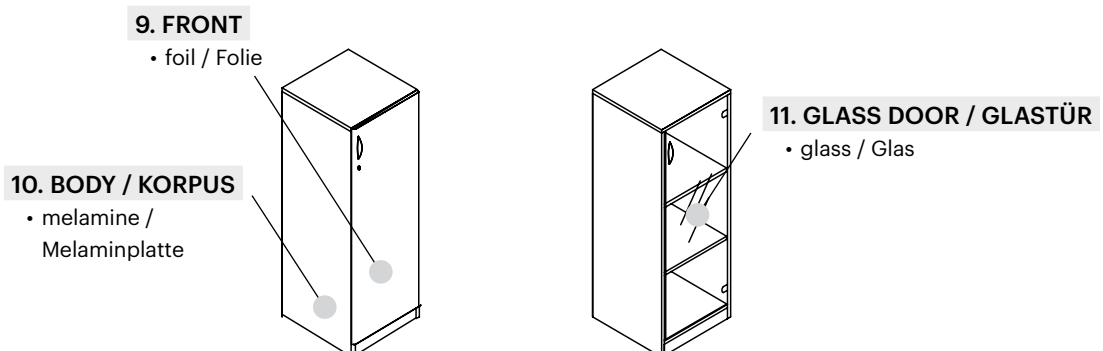







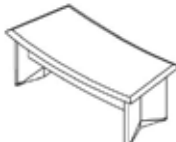

CABINETS / SCHRÄNKE

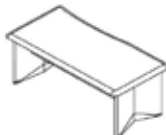

DESKS, TABLES, EXTENTION DESKS / SCHREIBTISCHE, TISCHE, ANSÄTZTISCHE	PEDESTALS / CONTAINER	CABINETS / SCHRÄNKE
<p>1. TOP / TISCHPLATTE</p> <hr/> <p>foil / Folie</p> <ul style="list-style-type: none"> - oak / Eiche 3600 - light walnut / helle Nuss 3200 - dark walnut / dunkle Nuss 3100 <p>2. 3. BOTTOM PART AND FRAME / PLATTE UNTER DEM SCHREIBTISCH UND GESTELL</p> <hr/> <p>varnished MDF mat / MDF lackiert Struktur</p> <ul style="list-style-type: none"> - dark graphite / Intensives Grafit W - true grey / echtes Grau Z - white / weiß R - sand / Sand TS <p>4. BOTTOM FRAME / GESTELL</p> <hr/> <p>varnished MDF mat / MDF lackiert Struktur</p> <ul style="list-style-type: none"> - deep grey / Tiefes Grau U - true grey / echtes Grau Z - white / weiß R - sand / Sand TS 	<p>8. FRONT / FRONTEN</p> <hr/> <p>foil / Folie</p> <ul style="list-style-type: none"> - oak / Eiche 3600 - light walnut / helle Nuss 3200 - dark walnut / dunkle Nuss 3100 <p>7. BODY / KORPUS</p> <hr/> <p>melamine board / Melamin</p> <ul style="list-style-type: none"> - graphite / graphit 0300 - white / weiß 2700 - true grey / echtes Grau 1208 - sand / Sand 2850 <p>6. TOP RING / ABDECKPLATTE</p> <hr/> <p>foil / Folie</p> <ul style="list-style-type: none"> - oak / Eiche 3600 - light walnut / helle Nuss 3200 - dark walnut / dunkle Nuss 3100 	<p>9. FRONT / FRONTEN</p> <hr/> <p>foil / Folie</p> <ul style="list-style-type: none"> - oak / Eiche 3600 - light walnut / helle Nuss 3200 - dark walnut / dunkle Nuss 3100 <p>11. GLASS DOOR / GLASTÜR</p> <hr/> <p>glass / Glas</p> <ul style="list-style-type: none"> - clear / klar <p>10. BODY / KORPUS</p> <hr/> <p>melamine board / Melamin</p> <ul style="list-style-type: none"> - graphite / graphit 0300 - white / weiß 2700 - true grey / echtes Grau 1208 - sand / Sand 2850

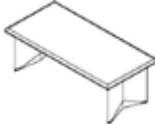
PRICES / PREISE

DESKS / SCHREIBTISCHE						
VIEW AND PROJECTION OF THE OBJECT / ANSICHT DES OBJEKTS	DIMENSIONS (in cm) / ABMESSUNGEN (in cm)			CATALOGUE NUMBER / PRODUKT- SYMBOL	NET PRICE in EUR / NETTOPREIS in €	REMARKS / BEMERKUNGEN
	WIDTH / BREITE	DEPTH / TIEFE	HEIGHT / HÖHE			
	200	100	74	M01	1 182	
	180	90		M02	1 045	
 left / links  right / rechts 	220	110	74	M03	1 363	
				M04		
 	200	90	74	M05	1 246	
 right / rechts  left / links 	180	90	74	M06	1 099	
				M07		
CONFERENCE TABLES / KONFERENZTISCHE						
	234	120	74	M08	1 657	
	200	100	74	M46	1 182	
	180	90	74	M47	1 045	
MODULAR CONFERENCE TABLE / KONFERENZTISCHE						
	120	120	74	M09	816	end-module of a conference table. Used for creating a modular conference table. For joining M9 and M10, two elements M11 are necessary. / Endelement, um M9 und M10 zur verbinden bitte 2xM11 verwenden
	140	120	74	M10	844	middle-module of a conference table. Used for creating a modular conference table. For joining M9 and M10, two elements M11 are necessary. / Mitelement um 2xM10 zur verbinden bitte M12 verwenden

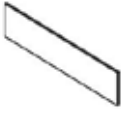

CONNECTORS OF CONFERENCE TABLES / VERBINDUNGSELEMENTE ZUM KONFERENZTISCH

VIEW AND PROJECTION OF THE OBJECT / ANSICHT DES OBJEKTS	DIMENSIONS (in cm) / ABMESSUNGEN (in cm)			CATALOGUE NUMBER / PRODUKT-SYMBOL	NET PRICE in EUR / NETTOPREIS in €	REMARKS / BEMERKUNGEN
	WIDTH / BREITE	DEPTH / TIEFE	HEIGHT / HÖHE			
	147	2,5	32	M11	88	for joining M9 and M10, two pieces are necessary / um M9 und M10 zur verbinden bitte 2xM11 verwenden
	136			M12	83	for joining two elements M10, two pieces are necessary / um 2xM10 zur verbinden bitte 2xM12 verwenden





ELECTRICAL POWER ADAPTER / BEFESTIGUNGSSÄULE

	11	34	M19	521	cable kolumn with Power supply facility: 3 sockets 230V, 2 net sockets (RJ 45) / VerstärkungsLeiste: 3 Steckdosen 230V, 2 Netzanschlüsse (RJ 45)
--	----	----	-----	-----	--

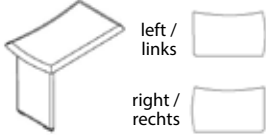

TABLES / TISCHE



	120	120	74	M13	1 011
	79	79	60	M18	502



PC EXTENSION DESKS / ANSATZTISCH





 left / links  right / rechts 	98	60	74	M14	343	perpendicular extension desk / Ansatz Tisch senkrecht
	109	100	74	M16	748	lengthwise / Ansatz Tisch entlang
	107	90		M17	676	

PRICES / PREISE

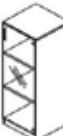

PEDESTALS / CONTAINER						
VIEW AND PROJECTION OF THE OBJECT / ANSICHT DES OBJEKTS	DIMENSIONS (in cm) / ABMESSUNGEN (in cm)			CATALOGUE NUMBER / PRODUKT- SYMBOL	NET PRICE in EUR / NETTOPREIS in €	REMARKS / BEMERKUNGEN
	WIDTH / BREITE	DEPTH / TIEFE	HEIGHT / HÖHE			
	45	60	61	M20	563	pedestal with pencil case, three metal drawers / Container mit Zentralverschluss, Materialauszug, Schubladen (Metall)
				M21	563	pedestal with pencil case, metal drawer and bottom drawer for hanging files / Container mit Zentralverschluss, Materialauszug, Schublade, Hängeregistratur
				M22	239	pedestal with door open on right side / Container, Tür Rechts



CABINETS / SCHRÄNKE						
	40	41	78	M23	234	cabinet with temper glass door / Schrank mit Glastür, Hartglas
	40	42	78	M24	198	file cabinet with three point lock / Aktenschrank, Verschluss
	49	48	83	M25	1 661	cabinet with mini fridge in top cabinet ring ventilator / Kühl-schrank minibar

CABINETS 2OH / SCHRÄNKE 2OH						
VIEW AND PROJECTION OF THE OBJECT / ANSICHT DES OBJEKTS	DIMENSIONS (in cm) / ABMESSUNGEN (in cm)			CATALOGUE NUMBER / PRODUKT-SYMBOL	NET PRICE in EUR / NETTOPREIS in €	REMARKS / BEMERKUNGEN
	WIDTH / BREITE	DEPTH / TIEFE	HEIGHT / HÖHE			
	80	40	78	M26	148	open file cabinet / Regal
	80	41	78	M27	399	cabinet with temper glass door / Schrank mit Glastür, Hartglas
	80	42	78	M28	308	file cabinet with three point lock / Aktenschrank, Verschluss

CABINETS 3OH / SCHRÄNKE 3OH						
	40	42	114	M29	280	file cabinet with three point lock / Aktenschrank, Verschluss
	40	41	114	M30	298	cabinet with temper glass door / Schrank mit Glastür, Hartglas
	80	40	114	M31	196	open file cabinet / Regal
	80	41	114	M32	495	cabinet with temper glass door / Schrank mit Glastür, Hartglas
	80	42	114	M33	419	file cabinet with three point lock / Aktenschrank, Verschluss

PRICES / PREISE

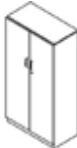
CABINETS 3OH / SCHRÄNKE 3OH						
VIEW AND PROJECTION OF THE OBJECT / ANSICHT DES OBJEKTS	DIMENSIONS (in cm) / ABMESSUNGEN (in cm)			CATALOGUE NUMBER / PRODUKT-SYMBOL	NET PRICE in EUR / NETTOPREIS in €	REMARKS / BEMERKUNGEN
	WIDTH / BREITE	DEPTH / TIEFE	HEIGHT / HÖHE			
	40	42	150	M34	416	cabinet with tempered glass door, three point lock / Schrank mit Glastüren (Hartglas) Verschluss
	40	42	150	M35	361	file cabinet with three point lock / Aktenschrank, Verschluss
	80	40	150	M36	239	open file cabinet / Regal

CABINETS 4OH / SCHRÄNKE 4OH						
	80	42	150	M37	651	file cabinet with three point lock and tempered glass door / Schrank mit Glastür, Hartglas, Verschluss
				M38	519	file cabinet with three point lock / Aktenschrank, Verschluss
				M39	527	file wardrobe cabinet with three point lock / Garderobenschrank, Verschluss

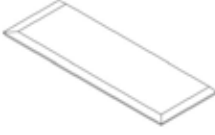
TOP CABINET RING / ABDECKPLATTE						
VIEW AND PROJECTION OF THE OBJECT / ANSICHT DES OBJEKTS	DIMENSIONS (in cm) / ABMESSUNGEN (in cm)			CATALOGUE NUMBER / PRODUKT- SYMBOL	NET PRICE in EUR / NETTOPREIS in €	REMARKS / BEMERKUNGEN
	WIDTH / BREITE	DEPTH / TIEFE	HEIGHT / HÖHE			
	42	43	5	M40	68	For assembling in cabinets of the width 40cm / Zum 40cm Schrankbreite
	82			M41	97	For assembling in cabinets of the width 80cm / Zum 80cm Schrankbreite
	122			M42	145	For assembling In cabinets of the same height, put together to the widt 120cm / Zum 120cm Schrankbreite
	162			M43	190	For assembling In cabinets of the same height, put together to the widt 160cm / Zum 160cm Schrankbreite
	202			M44	237	For assembling In cabinets of the same height, put together to the widt 200cm / Zum 200cm Schrankbreite
	242			M45	284	For assembling In cabinets of the same height, put together to the widt 240cm / Zum 240cm Schrankbreite

